

ThermoWood® HANDBOOK



TABLE OF CONTENTS

PREFACE	3
DEFINITIONS	4
1. THE DEVELOPMENT OF THERMALLY MODIFIED TIMBER	5
2. ThermoWood® MANUFACTURING PROCESS	6
2.1 Manufacturing process	6
2.2 Raw material	9
2.3 Changes in the wood structure	11
2.3.1 Carbohydrates	11
2.3.2 Lignin	12
2.3.3 Extractives	12
2.3.4 Toxicity of thermally modified timber	12
2.3.5 pH value of thermally modified timber	12
2.4 Production quality control	13
3. ENVIRONMENTAL IMPACTS	14
3.1 Raw material	14
3.2 Manufacturing process	14
3.3 Use and recycling	14
3.4 Life cycle	14
4. ThermoWood® PRODUCTS	15
4.1 Impact of thermal modification on timber dimensions	15
4.2 Profiled board products	16
4.3 CE marking	17
4.4 Product classification	18
4.5 Physical properties	20
4.5.1 Density	20
4.5.2 Bending strength and modulus of elasticity	21
4.5.3 Screw holding strength	22
4.5.4 Compression strength perpendicular to grain	23
4.5.5 Compression strength parallel to grain	23
4.5.6 Impact bending strength (dynamic bending)	23
4.5.7 Shear strength	23
4.5.8 Splitting strength	23
4.5.9 Hardness	24
4.5.10 Fire resistance	25
4.6 Thermomechanical properties	25
4.6.1 Equilibrium moisture content	25
4.6.2 Swelling and shrinkage due to moisture	26
4.6.3 Permeability	27
4.6.4 Thermal conductivity	27
4.7 Long-term durability	28
4.7.1 Weather resistance	28
4.7.2 Biological resistance	28
4.7.3 Resistance to insects	28
4.8 Impact on indoor air quality	29
5. PROCESSING OF ThermoWood® PRODUCTS	30
5.1 Sawing	30
5.2 Planing	30
5.3 Milling	31
5.4 Sanding	31
5.5 Gluing	31
6. SURFACE TREATMENT OF ThermoWood® PRODUCTS	32
6.1 ThermoWood® as a basis for surface treatment	32
6.2 The most commonly used surface treatment agents	32
6.3 Performance of surface treatment	32
6.4 Fire protection treatment	32
7. PROCUREMENT AND STORAGE OF ThermoWood® PRODUCTS	33
8. CONSTRUCTION INDUSTRY APPLICATIONS OF ThermoWood® PRODUCTS	34
8.1 Indoor use	34
8.2 Outdoor use	39
9. INSTALLATION OF ThermoWood® CLADDING PRODUCTS	43
9.1 Fasteners	43
9.2 Fixing	43
9.3 Joints	43
10. ThermoWood® IN THE CARPENTRY INDUSTRY	48
11. REFERENCES	50
11. FURTHER INFORMATION	55



Publisher:

International Thermowood Association,
Snellmaninkatu 13, 00170 Helsinki,
Finland
+358 400 802 896
info@thermowood.fi

Script and drawings:

Tero Lahtela,
Insinööritoimisto Lahtela Oy

Layout:

HannaR Ky

PREFACE

The use of thermally modified timber has increased significantly across the world over the past 20 years. Products and production techniques have been developed over the decades by manufacturers and the International Thermowood Association.

Thermally modified timber products are natural, chemical-free wood products that are made from certified raw materials. They have long life cycles and can be recycled.

Established in Finland in 2000, the International Thermowood Association is tasked with promoting the use of ThermoWood® products. Currently, the association consists of 16 companies from various countries.

This handbook offers essential information on thermally modified timber products sold under the ThermoWood® trademark. Its goal is to provide objective information on ThermoWood® products and their use. It is intended for Architects and structural designers, retailers, component and element manufacturers, contractors, carpenters and educational institutes.

The products and structures presented in this handbook are examples. Designers are always responsible for the design of the structures used in a project. Manufacturers of ThermoWood® timber offer a wide range of products and installation instructions for various applications. Because of this, it is recommended that you contact the manufacturer's technical customer service in matters related to the choice of products and technical data pertaining to them. This helps ensure that your design will offer high quality and a long service life.

The preparation of this handbook was overseen by Jukka Ala-Viikari, the executive director of the International Thermowood Association, and representatives of the association's members. The Foundation for Quality of Construction Products participated in the funding of the work on this handbook.

The ThermoWood® handbook is available in Finnish and English.

We would like to thank all those who participated in and contributed to this project.

Helsinki, April 2021



Timo Tetri

Chairman, International Thermowood Association



DEFINITIONS

ThermoWood®

Registered trademark, which may only be used by the members of the International Thermowood Association.

ThermoWood® product

A timber product produced using the thermal modification method developed in Finland. Production is harmonised and the producers have implemented an audited quality control system.

Thermal modification

A method in which the chemical properties of wood are modified with heat and steam. The minimum modification temperature is 160°C. The consequent changes in the wood structure are permanent.

ThermoWood® process

A ThermoWood® product manufacturing process developed and patented by the Technical Research Centre of Finland (VTT). The International Thermowood Association owns the patents. The ThermoWood® process is a global market leader.

Quality logo

(ITWA = International ThermoWood Association)

The International Thermowood Association's official ThermoWood® quality logo, which may only be used by the association's members with an audited quality control system.

PEFC

(Programme for the Endorsement of Forest Certification)

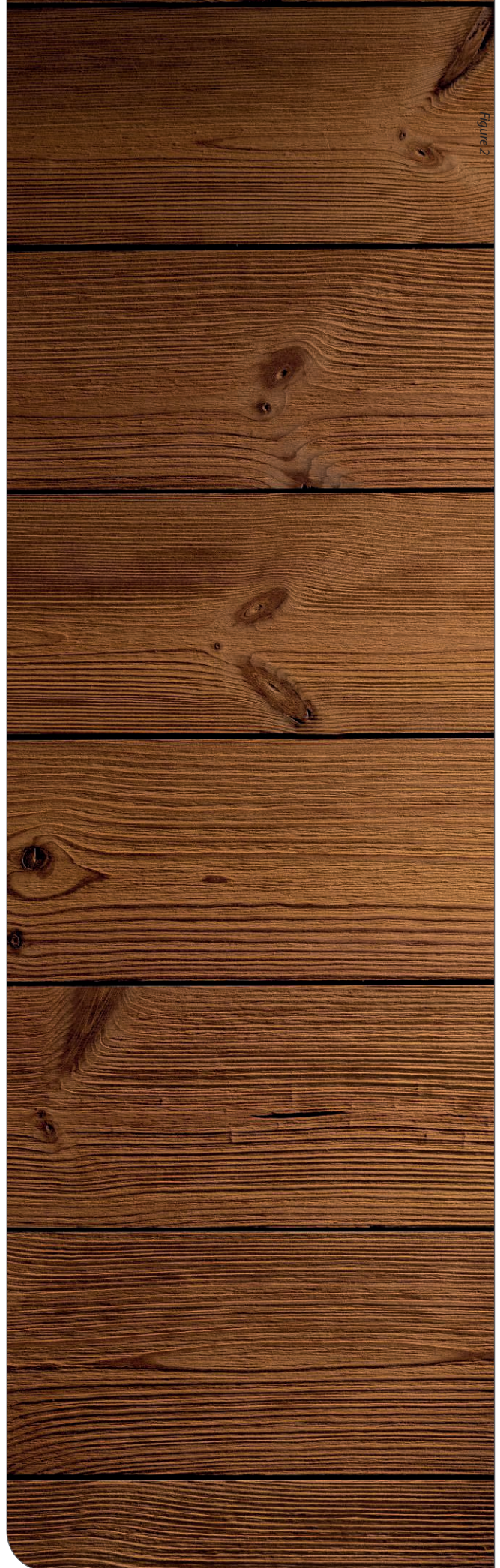
PEFC is an international forest certification system which promotes ecologically, socially and economically sustainable forest management globally.

FSC (Forest Stewardship Council)

FSC is an international non-profit organisation established to promote responsible management of the world's forests. It grants FSC certificates to services and products.

OLB (Origine et Légalité des Bois)

OLB is a certification system designed to verify the origin of timber and compliance with legal requirements in forest management and harvesting.



1

THE DEVELOPMENT OF THERMALLY MODIFIED TIMBER

The custom of charring the surface of wood to make it more resistant to moisture goes back all the way to ancient Egypt. The charred surface forms a protective layer, which improves wood's biological resistance. In Finland, this method was used to protect the underground sections of hay poles and fence posts against the moisture in the soil. It could be said that charring the surface of wood on an open fire was the first step towards the thermal modification of timber.

Thermal modification of wood in a kiln was first studied scientifically in the early 20th century. The goal was to learn how thermal modification improved the qualities of timber, in addition to enhancing its resistance to moisture, and to identify suitable applications for the treated wood. One of the research areas was the use of thermally modified timber in the aviation industry. Until the 1980s, research into thermal modification was carried out primarily in Germany and the US. The first commercial thermal modification facility was established in Germany in the early 1980s, but operations did not reach an industrial scale.

In the 1990s, Finland, France and the Netherlands were leaders in research into the thermal modification of wood. A major breakthrough in the field was made in Finland in 1993, when VTT, in collaboration with wood industry companies, developed the industrial-scale ThermoWood® process for improving the properties of timber with heat.

Today, ThermoWood® is an international brand and its production volumes are increasing steadily. Thermally modified timber manufactured using the ThermoWood® process is produced across the world, in countries such as Finland, Sweden, Poland, Portugal, Belgium, Turkey, Japan, Canada and Iran. The range of thermally modified timber's applications has expanded rapidly to cover cladding and interior design products, patio and garden construction and the carpentry industry.

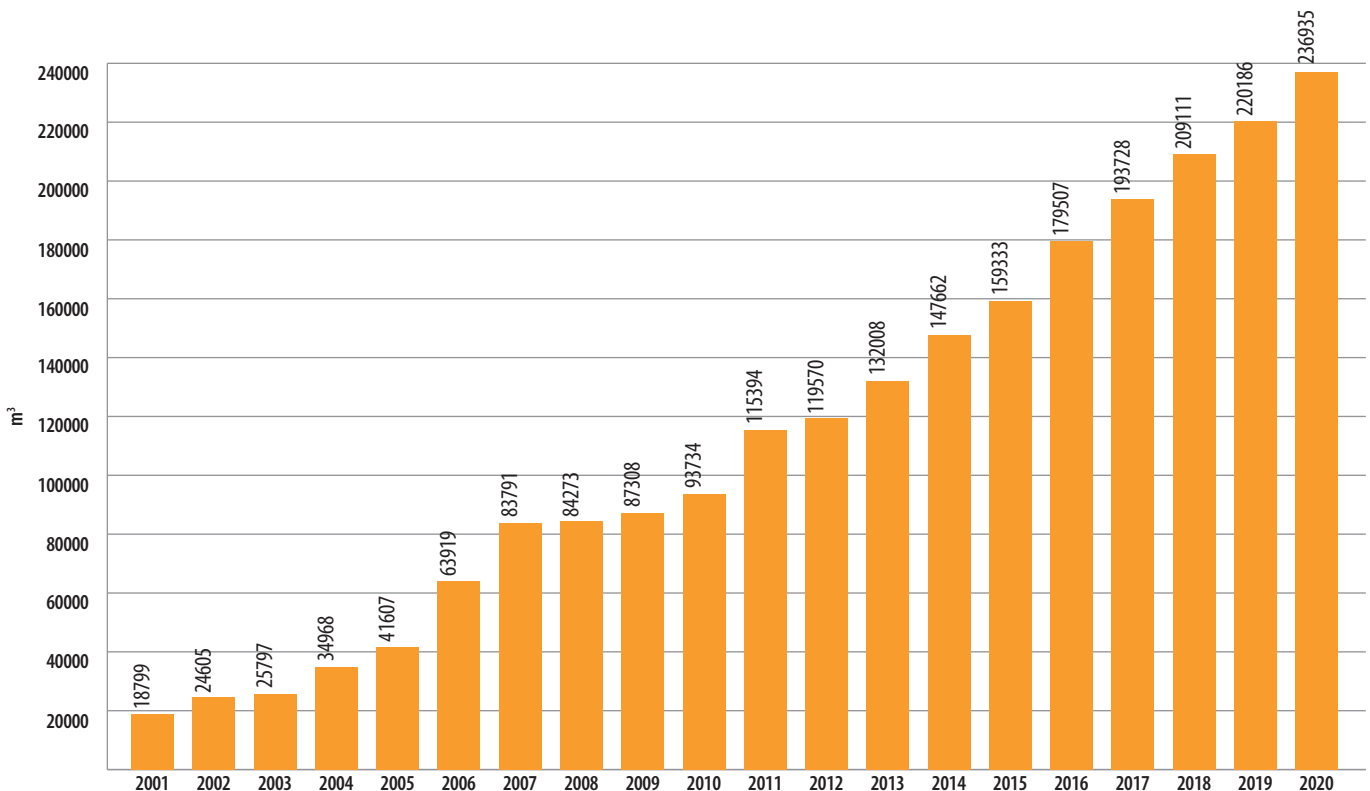


Figure 1. Changes in ThermoWood® production between 2001 and 2020.

2

ThermoWood® MANUFACTURING PROCESS

No chemicals are used in the production of ThermoWood® products. All raw materials are procured from certified sources. The production method is a result of extensive development work and it is based on the controlled modification of timber with heat, steam and water. The modification phases are high-temperature drying, thermal modification and cooling, and moisture conditioning. The process results in permanent physical and chemical changes in the wood. The new properties remain unchanged, even when the timber is processed with methods such as sawing or planing. This also applies to the colour of the product (through-stained).

There are two classes of ThermoWood®: Thermo-S and Thermo-D (see section 4.4). ThermoWood® products differ from standard timber in several ways, for example:

- Reduced swelling and shrinkage due to moisture
- Enhanced dimensional stability
- Better biological durability
- Darker colour (through-stained)
- No resin
- Lower thermal conductivity



Figure 4. ThermoWood® being manufactured in process kiln.

2.1 MANUFACTURING PROCESS

Thermal modification of timber takes place in industrial-scale facilities. The ThermoWood® process is suitable for both hardwoods and softwoods and it is always optimised for the wood species used as the raw material. At the start of the process, timber is turned into batten bundles, which are transferred to the kiln. During thermal modification, the timber is protected by means of steam, which also influences the permanent changes that take place in the timber. The ThermoWood® process can be divided into three main phases.

Phase 1: High-temperature drying

The kiln is heated rapidly to 100°C. After this, the temperature is gradually increased to the desired level. During this process, the timber dries and its moisture content decreases to zero.

Phase 2: Thermal modification

After high-temperature drying, the kiln is maintained at a steady temperature and the actual modification takes place.

Phase 3: Cooling/conditioning

During the last phase, the temperature in the kiln is decreased with a water-spray system. When the temperature is sufficiently low, the timber's moisture content is increased using water and steam to improve its machinability and dimensional stability. After the cooling phase, the moisture content of ThermoWood® products is 4–7%.

The duration of the ThermoWood® process depends on the product class (Thermo-S or Thermo-D), wood species and the raw material's moisture content and dimensions. The product gains its brown colour during the process when the heat changes its chemical properties. During thermal modification, softwoods secrete resin and other organic compounds. Extractives are also removed from hardwoods. A special control system is used to adjust the temperature to prevent the wood from cracking. Different settings are used for different wood species and timber dimensions.

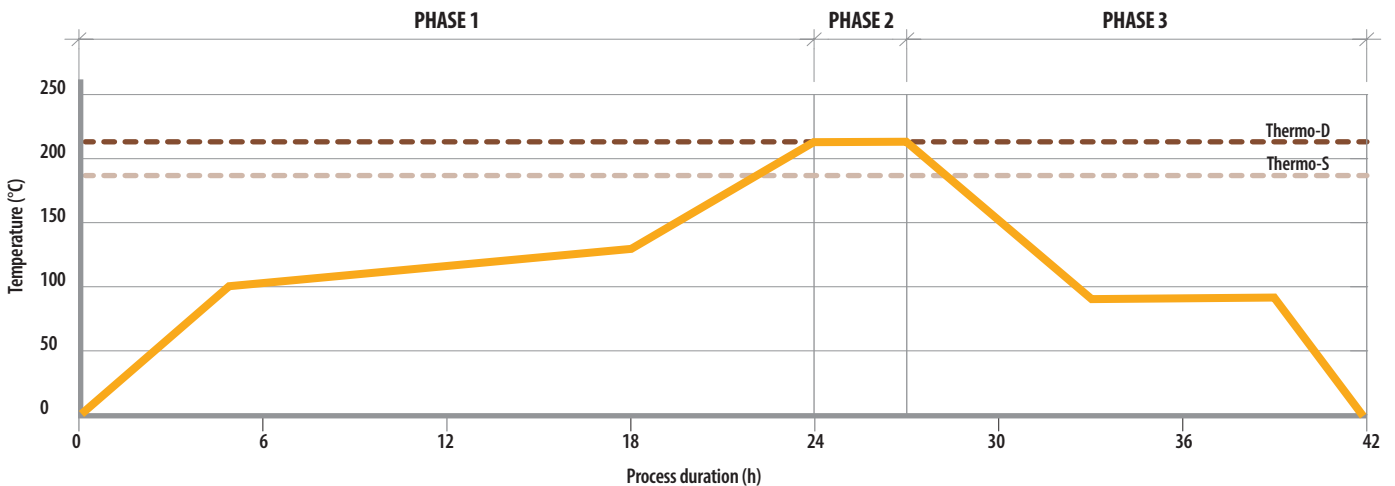
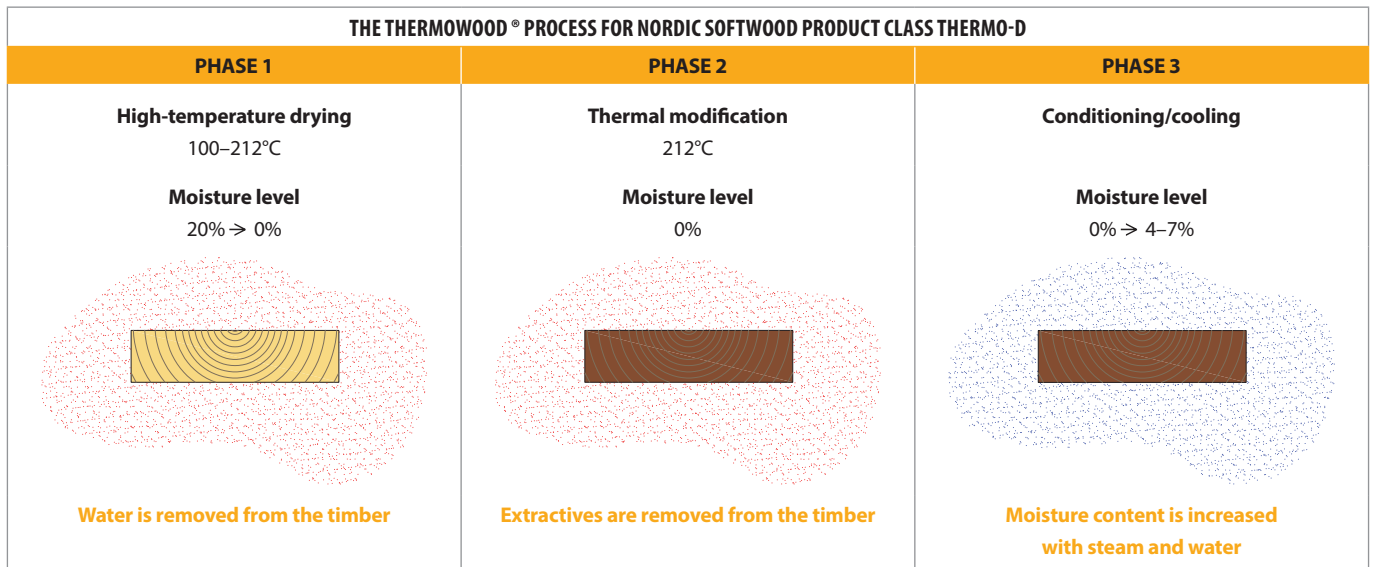


Figure 5. An example of the ThermoWood® process for Nordic softwood (product class Thermo-D).



Figure 6. ThermoWood® kiln.

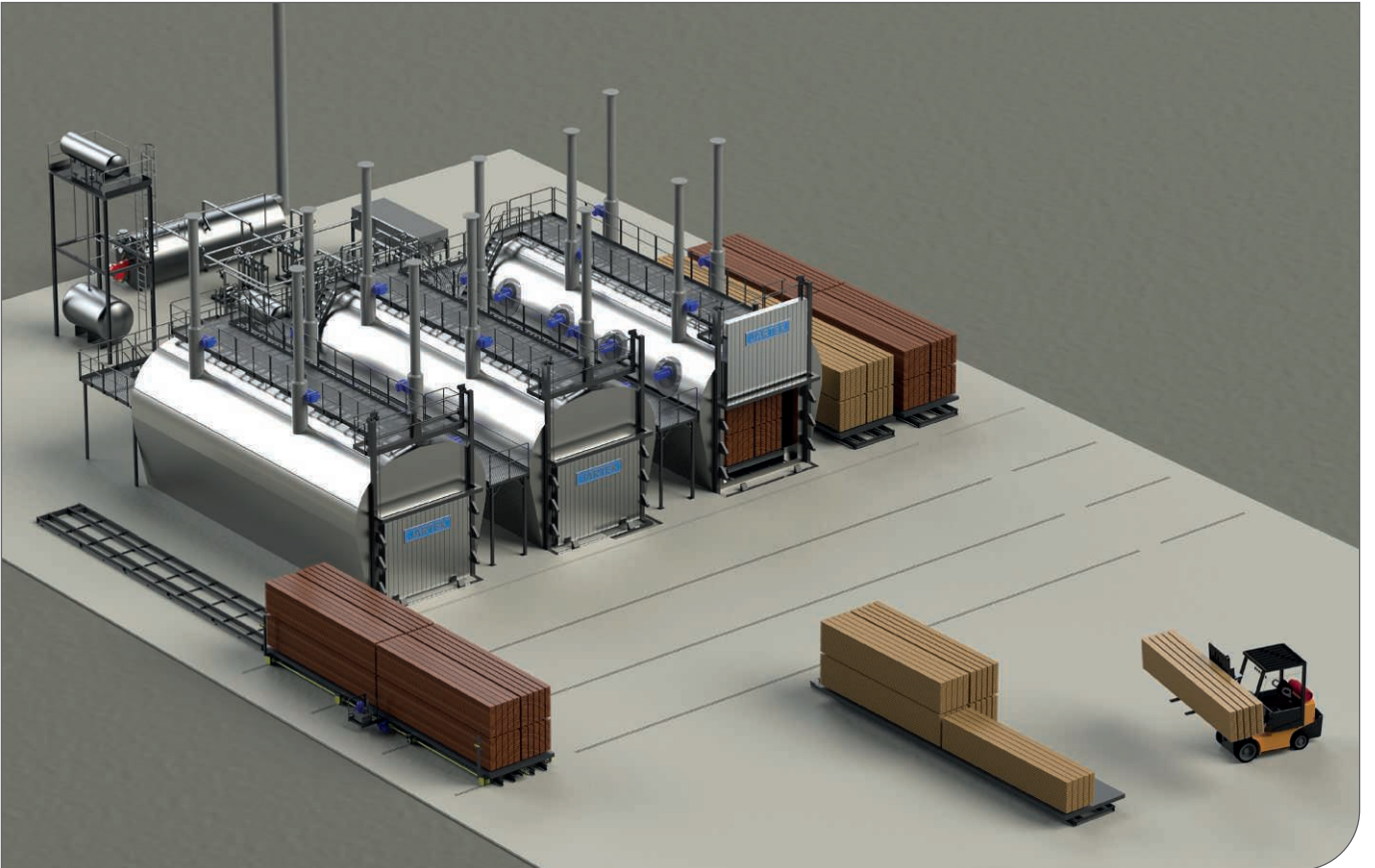


Figure 7. ThermoWood® plant.

Thermo-S



Thermo-D



Figure 8. Examples of ThermoWood® products made of Nordic softwood (left: Thermo-S, right: Thermo-D).

2.2 RAW MATERIAL

Selected sawn timber is used as the raw material. From Nordic softwood, heartwood is used. The quality of the raw material is monitored throughout the production process. Selecting suitable raw material is essential in order to achieve a high quality product. In principle, thermal modification can be used for various wood species, but the raw material's properties greatly influence the end result.

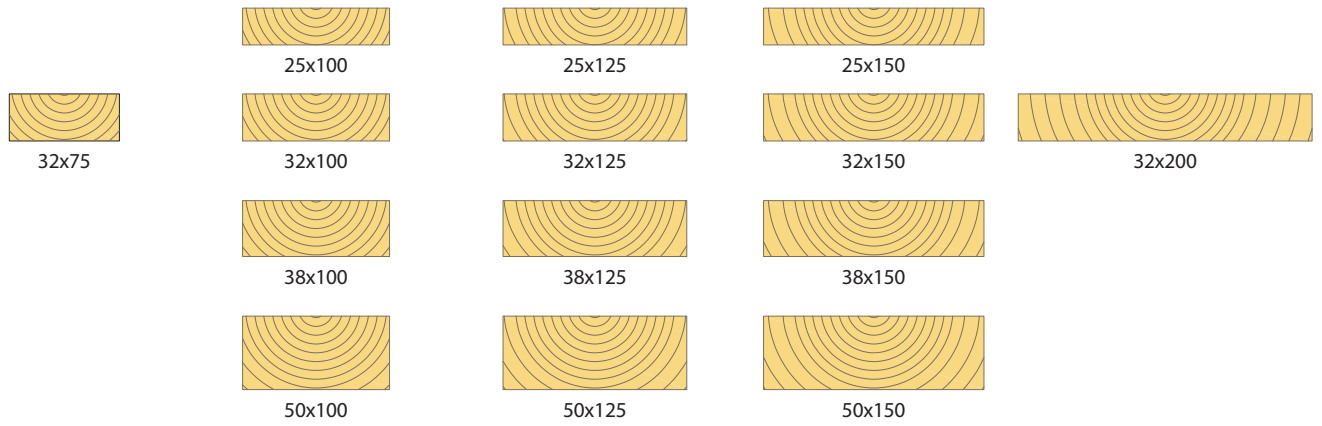
Currently, ThermoWood® products are only made from the wood species listed in Table 1 because scientific studies have shown them to meet the quality requirements set for the finished product. More research is continuously being carried out into thermally modified timber and as the results become available, more species will be introduced to the ThermoWood® range. Separate process instructions have been prepared for each wood species, and thermal modification is performed in line with these instructions.

The typical nominal dimensions of timber used to make ThermoWood® products are presented in Figure 9. The length of softwood timber typically ranges between 2.7 and 5.7 m, and between 1.8 and 4.2 m for hardwood. Other dimensions and lengths are available by special order.

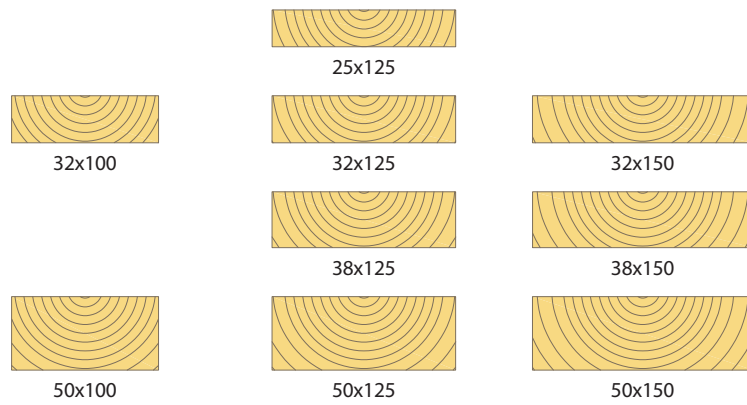
Table 1. Wood species used for ThermoWood® products.

Wood species	Type	Hardness	Origin	Product class
Pine (<i>Pinus sylvestris</i>)	Softwood	Soft	Nordic and Baltic regions	Thermo-D, Thermo-S
Spruce (<i>Picea abies</i>)	Softwood	Soft	Nordic and Baltic regions	Thermo-D, Thermo-S
Radiata pine (<i>Pinus radiata</i>)	Softwood	Soft	New Zealand, Chile	Thermo-D, Thermo-S
Birch (<i>Betula</i>)	Hardwood	Hard	Nordic and Baltic regions	Thermo-D, Thermo-S
Aspen (<i>Populus tremula</i>)	Hardwood	Soft	Nordic and Baltic regions	Thermo-D, Thermo-S
Ash (<i>Fraxinus excelsior</i>)	Hardwood	Hard	Europe, North America	Thermo-D, Thermo-S
Ayous (<i>Triplochiton scleroxylon</i>)	Hardwood	Hard	Africa	Thermo-D, Thermo-S
Frake (<i>Terminalia superba</i>)	Hardwood	Hard	Africa	Thermo-D, Thermo-S

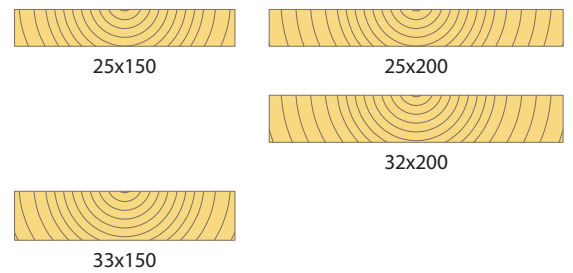
Pine



Spruce



Radiata pine



Aspen, birch, ash

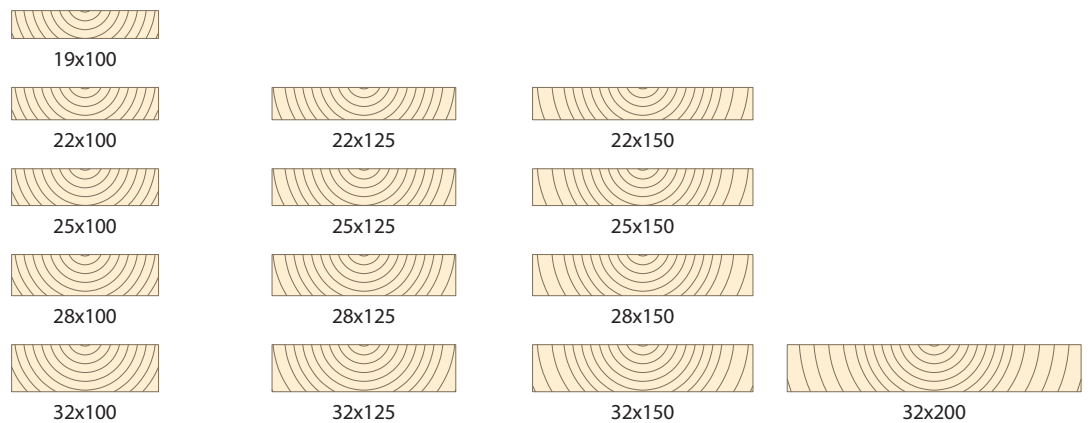


Figure 9. Examples of the nominal dimensions of timber used for ThermoWood® products.

2.3 CHANGES IN THE WOOD STRUCTURE

The main components of wood are cellulose (40–50%), hemicelluloses (25–35%) and lignin (25–30% in softwoods and 20–25% in hardwoods). In addition, wood contains extractives (about 5%).

2.3.1 Carbohydrates

Cellulose and hemicelluloses are carbohydrates, which are structural components of wood. Cellulose is a long chain (DP 5,000–10,000) made up of glucose units, while hemicelluloses are shorter chains (DP 150–200) made up of various monosaccharides. The composition and amounts of hemicelluloses vary from one wood species to another. While both groups undergo changes during thermal modification, the majority of the changes occur in hemicelluloses with high oxygen content.

Cellulose components, β -D-glycopyranoses, are joined by (1 \rightarrow 4)-glycoside bonds. Cellulose chains are joined by bonds between hydroxyl groups. At temperatures below 300°C, the degree of polymerisation during cellulose decomposition decreases, water is eliminated, and free radicals, carbonyl, carboxyl and hydroperoxide groups, carbon monoxide, carbon dioxide and reactive wood charcoal are generated.

The constituents of hemicelluloses include D-glucose, D-mannose, D-galactose, D-xylose and L-arabinose, along with L-rhamnose, 4-O-methyl-D-glucuronic acid and D-galacturonic acid in smaller quantities. They are bound to each other by (1 \rightarrow 4)- or (1 \rightarrow 6)-bonds.

As wood is heated, acetic acid is formed from acetylated hemicelluloses by hydrolysis. The released acid serves as a catalyst in the hydrolysis of hemicelluloses to soluble sugars. In addition, the acetic acid depolymerises cellulose microfibrils in the amorphous area. The acid hydrolyses the bonds joining glucose units together, breaking the cellulose into shorter chains.

After thermal modification, the timber's hemicellulose content is significantly lower. As a result, the amount of material that saprotrophic fungi can decay is significantly lower, which contributes to the thermally modified timber's improved resistance to fungal decay compared with standard wood. As the hemicelluloses degrade, the concentration of water-absorbing hydroxyl groups decreases and the dimensional stability of thermally modified timber improves, compared with untreated wood.

The decomposition temperature of the hemicelluloses is 200–260°C, and the corresponding temperature for cellulose is 240–350°C. Since hardwood species contain more hemicelluloses than softwoods, decomposition takes place more readily in them. However, the breaking of hemicellulose chains has a smaller impact on the strength of the wood than the degradation of cellulose chains would do. Instead, this makes the wood easier to compress and reduces the generation of stresses in it, making it more stable.

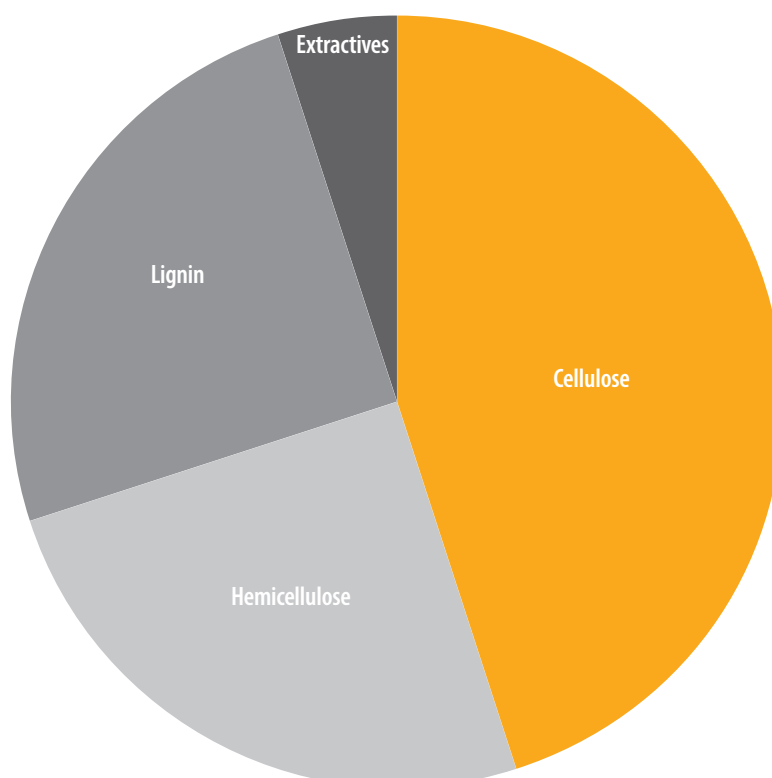


Figure 10. Approximate proportions of wood's main components.

2.3.2 Lignin

Lignin holds the wood cells together. The dark matter in the wood cells' middle lamellae mainly consists of lignin. It is also found in the primary and secondary cell walls. While the precise chemical structure of lignin is yet to be determined, its precursors have been known for decades. Lignin is primarily composed of phenylpropane units, which are typically joined together by ether- and carbon-carbon bonds (DP 10–50). Softwoods contain mainly guaiacyl units of phenylpropane, whereas hardwoods contain phenylpropane's guaiacyl and syringyl units in almost equal amounts. Both also contain small amounts of p-hydroxyl phenylpropane.

During thermal modification, bonds between phenylpropane units are partly broken. Aryl ether bonds between syringyl units break more easily than bonds between guaiacyl units. Thermochemical reactions are more common in allylic side chains than in aryl-alkyl ether bonds. The longer the autohydrolysis time, the more condensation reactions occur. The condensation reaction products include b-ketone groups and conjugated carboxylic acid groups.

Of all wood's constituents, lignin is the best able to withstand heat. Its mass only begins to decrease at temperatures higher than 200°C, when the b-aryl ether bonds start to break. At high temperatures, lignin's methoxy content decreases and some of its non-condensed units are transformed into diphenylmethane-like units. Accordingly, diphenylmethane-type condensation is the most common reaction within the temperature range of 120–220°C. During thermal modification, this reaction has a significant effect on lignin's properties, such as its colour, reactivity and dissolution.

2.3.3 Extractives

Wood contains minor amounts of small-molecule constituents, extractives, which include terpenes, fats, waxes and phenols. Extractives from various wood species are heterogenic in nature, and the number of compounds is extremely high. Extractives are not structural components of the wood, and most of the compounds evaporate easily during thermal modification.

2.3.4 Toxicity of ThermoWood®

The ecotoxicity of the leachates of thermally modified spruce has been tested at CTBA (EU project: Up-grading of non-durable wood species by appropriate pyrolysis thermal treatment, 1998). The tests were carried out on leachates obtained after an EN 84 test. This test is applied to evaluate the fixation of the biocides in wood cells. Small samples were leached with water, and the water was then tested in accordance with NF-EN ISO 506341 with *Daphnia magna* (a small freshwater shellfish) and microtoxicity tests were performed on marine luminescent bacteria. The test results showed that leachates do not contain substances that are toxic to *Daphnia magna* and that they are harmless to bacteria.

ThermoWood® has also been tested as a bone substitute material (VTT & Surgical Clinic at the University Hospital in Turku). Preliminary tests produced promising results: ThermoWood® birch has similar properties to bone. ThermoWood® is sterile, and no toxic substances have been identified in it.

2.3.5 pH value of ThermoWood®

During thermal modification, timber's pH value decreases, making thermally modified products significantly more acid than standard timber. The pH value of ThermoWood® product is about 4, whereas the pH value of a corresponding standard product is between 4.5 and 5. In the comparison of pH values, it should be noted that a decrease of 0.3 units in the pH value translates into a doubling of the amount of acid (logarithmic scale). Acidity affects surface treatment because it may prevent some surface treatment agents from adhering to the surface of the timber. It may also have an impact on the corrosion of metal fasteners. Because of this, metal fasteners used with thermally modified timber should be made of acid-resistant or stainless steel.

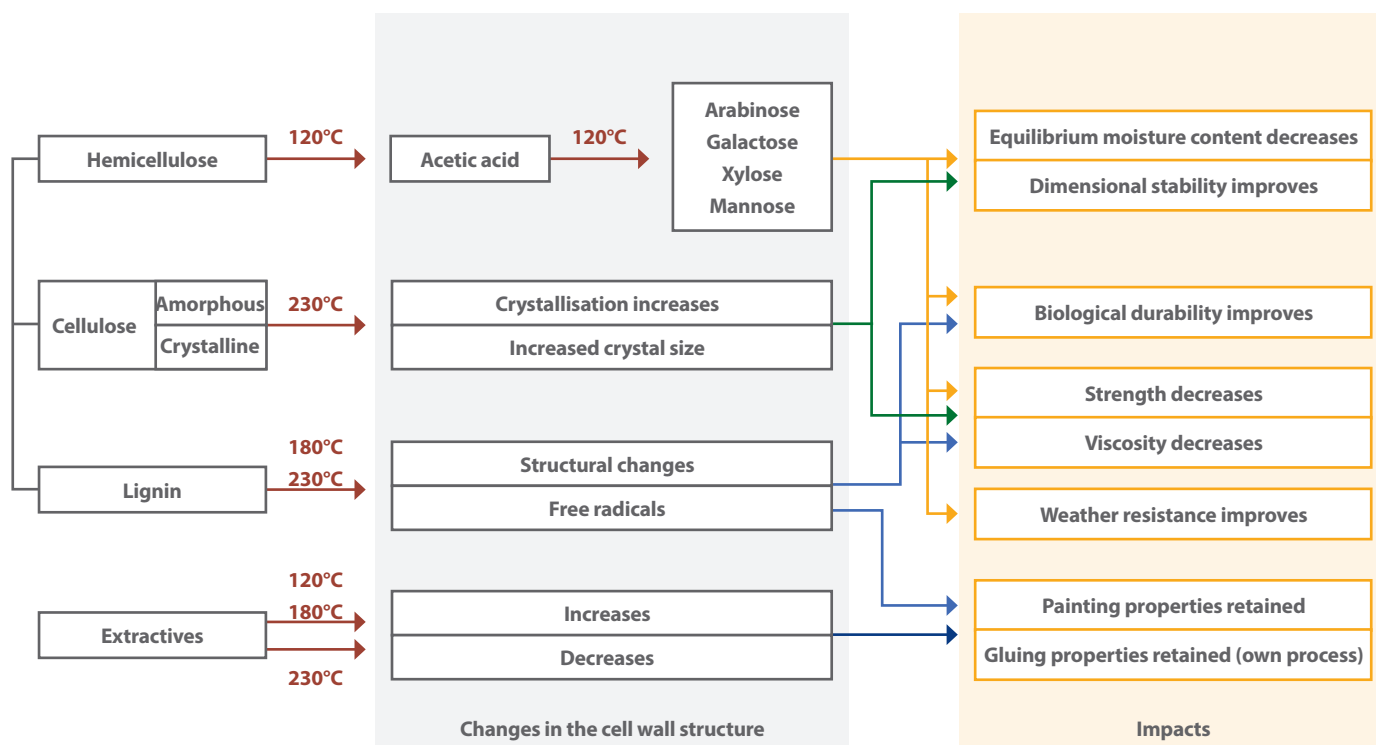


Figure 11. Reaction mechanisms of thermally modified timber (source: VTT)

2.4 PRODUCTION QUALITY CONTROL

The quality of the ThermoWood® process and products is monitored by an external, accredited inspection facility. This facility certifies the ThermoWood® production plant's quality control system.

The production plant is responsible for quality control and for ensuring the following factors:

- A description of the internal quality control system is prepared, including information on the facility's operational diagram, production process, equipment, handling of deviations and product inspections
- Persons responsible for production and deputies for them are appointed
- Persons responsible for quality control and deputies for them are appointed
- Production premises and equipment meet the requirements
- Measures related to the servicing and maintenance of equipment comply with the requirements
- All aspects of the devices on the test premises and their calibration meet the requirements
- Production and quality control documents are prepared and archived in line with the requirements

The production plant must be audited at least once a year to ensure that quality control measures comply with the requirements. Finished products are tested once a year by an approved external testing laboratory. The pieces to be tested are selected by the auditor's representative. During quality control, the following properties are inspected:

- Moisture level
- Surface and interior cracks
- Colour
- Process parameters

Any deviations are reported to the quality control certification board. If the production plant fails to meet the requirements, its certification may be revoked.

3 ENVIRONMENTAL IMPACTS

3.1 RAW MATERIAL

Certified raw materials are used to make ThermoWood® products. PEFC, FSC and OLB are the certification systems used for the products.

3.2 MANUFACTURING PROCESS

ThermoWood® products are natural, chemical-free wood products. Process gases released from the wood during the production process are purified.

3.3 USE AND RECYCLING

By-products generated during the production process can be used for energy generation or recycled as raw material for composite materials, for example.

3.4 LIFE CYCLE

ThermoWood® products offer a long service life and they do not necessarily require maintenance. These factors reduce the environmental impact of ThermoWood® products during use. When they reach the end of their service life, thermally modified timber products can be utilised in a manner similar to other timber.



Figure 12. Nordic forest

4 ThermoWood® PRODUCTS

The ThermoWood® process typically produces rough-sawn timber, which is then processed into finished products. The main product categories include interior and exterior cladding, garden construction products and carpentry industry products.

4.1 IMPACT OF THERMAL MODIFICATION ON TIMBER DIMENSIONS

Thermal modification significantly decreases timber's moisture content (see Figure 13). The shrinkage caused by this reduces timber's nominal dimensions.

For example, ThermoWood® products with nominal dimensions of 25x125 are actually about 3% smaller (24x121). In addition, a deviation of -2 to +4 mm is permitted in the width and -1 to +3 mm in the thickness of ThermoWood® timber. A certain degree of cupping is also permitted during thermal modification.

The above-mentioned factors must be taken into account in the choice of the raw material for thermal modification. A ThermoWood® panel is also significantly thinner than the raw material used to produce it. The product's thickness also depends on whether all areas of its back are planed.

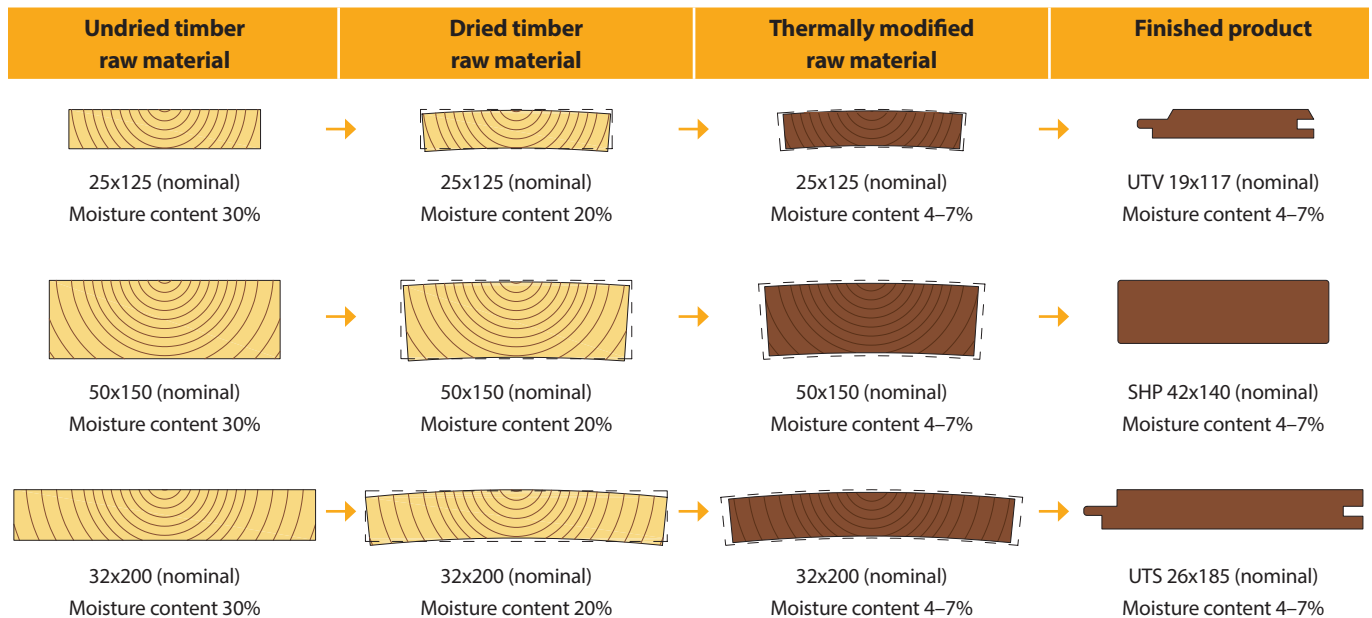


Figure 13. Examples of the impact of thermal modification on product dimensions.

4.2 PROFILED BOARD PRODUCTS

ThermoWood® is used to produce a wide range of interior and exterior cladding materials, trimmings, decking boards and boards for sauna benches. While these products are usually planed, products with a brushed, fine sawn or fine roughened surface are also available. Products with industrial surface treatment are also available. ThermoWood® profile boards may not have grooves on the back because these are not necessary, due to the material's good dimensional stability.

Typical ThermoWood® profile products are presented in Figure 14. Manufacturers of ThermoWood® also offer a wide range of their own products, and detailed information on profiles, dimensions, surface types and surface treatments is available in the manufacturer's instructions.

The recommended product thicknesses are:

Outdoor use

- Wall and ceiling cladding: min. thickness of 19 mm
- Patios and similar structures: min. thickness of 26 mm

Indoor use

- Wall and ceiling cladding: min. thickness of 14 mm
- Floorboards: min. thickness of 26 mm

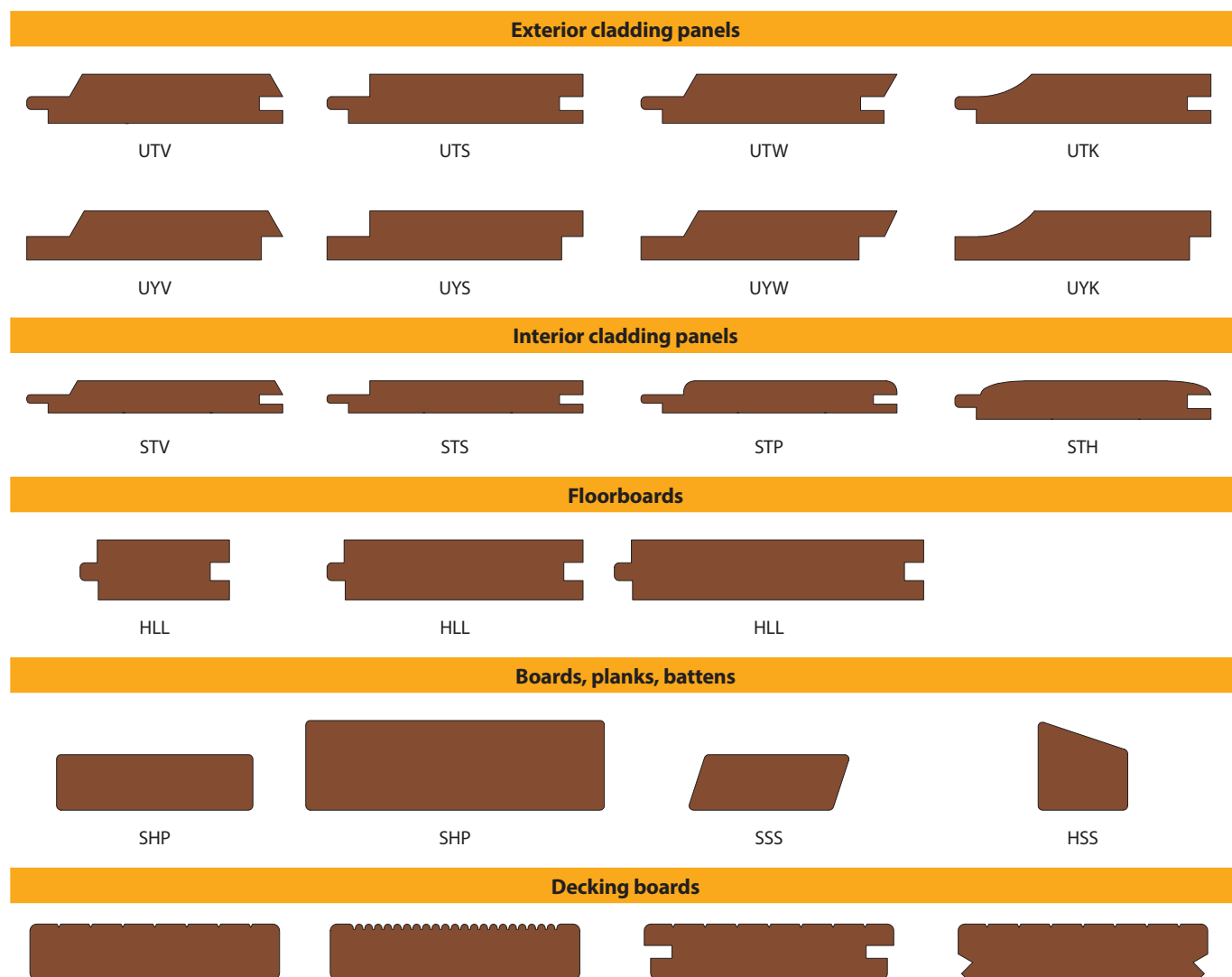


Figure 14. Examples of ThermoWood® profile products.

4.3 CE MARKING

Similarly to standard timber, thermally modified timber does not typically carry a CE marking. However, wooden panels and cladding products intended for outdoor and indoor use within the EU must carry the CE marking pursuant to standard SFS-EN 14915. Correspondingly, floorboards and wooden flooring materials must be CE-marked in line with standard SFS-EN 14342. The marking can be either on the package or the product itself.

Wood products with a decorative surface that require CE marking:

- wooden indoor panels
- wooden exterior cladding products
- floorboards



Figure 15. An example of a cladding panel (Nordic spruce).



Figure 16. An example of boards for sauna benches (Nordic spruce).



Figure 17. An example of a plank (Nordic spruce).



Figure 18. An example of a decking board (Nordic spruce).



Figure 19. An example of cladding panels (ayous).



Figure 20. An example of cladding panels (ash).

4.4 PRODUCT CLASSIFICATION

ThermoWood® products have their own product classification system, which is used to determine suitable applications. There are two product classes: Thermo-S and Thermo-D. Both softwoods and hardwoods are available in these classes. Within a product class, softwood and hardwood products are treated as separate products because of their different properties and modification temperatures.

In the product classification:

- S = stability
- D = durability
(stability and resistance to decay and weather)

Table 2. The impact of thermal modification on the timber's properties in the Thermo-S class.

Product class	Modification temperature	Property compared with that of untreated wood (+ = enhanced property) (++ = significantly enhanced property) (o = remains unchanged)		
		Weather resistance	Dimensional stability	Darkness
Thermo-S Nordic softwoods	190°C (+/- 3°C)	+	+	+
Thermo-S Radiata pine	190°C (+/- 3°C)	o	o	o
Thermo-S Hardwoods	185°C (+/- 3°C)	o	+	+

Table 3. The impact of thermal modification on the timber's properties in the Thermo-D class.

Product class	Modification temperature	Property compared with that of untreated wood (+ = enhanced property) (++ = significantly enhanced property) (o = remains unchanged)		
		Weather resistance	Dimensional stability	Darkness
Thermo-D Nordic softwoods	212°C (+/- 3°C)	++	++	++
Thermo-230 °C Radiata pine	230°C (+/- 3°C)	++	++	++
Thermo-D Ayous (hardwood)	212°C (+/- 3°C)	+	+	++
Thermo-D Frake (hardwood)	212°C (+/- 3°C)	+	+	++
Thermo-D Ash (hardwood)	212°C (+/- 3°C)	+	+	++

Table 4. Examples of applications of ThermoWood®.

Applications	Nordic softwoods		Radiata pine		Ash		Ayous		Frake	
	Thermo-S	Thermo-D	Thermo-S	Thermo-230 °C	Thermo-S	Thermo-D	Thermo-S	Thermo-D	Thermo-S	Thermo-D
Interior cladding	•	•	•	•	•	•	•	•	•	•
Floors	•	•	•	•	•	•			•	•
Fixtures	•	•	•	•	•	•	•	•	•	•
Furniture	•	•	•	•	•	•	•	•	•	•
Wet indoor spaces	•	•	•	•	•	•	•	•	•	•
Window and wall structures	•	•			•		•		•	•
Exterior cladding	•	•	•	•	•	•	•	•	•	•
Patios		•		•		•				
Garden furniture		•				•				
Window hatches outdoors		•		•		•		•		•
Portable dividers, etc. outdoors		•		•		•		•		•
Fences, pergolas, etc.		•		•		•		•		•



Figure 21. ThermoWood® cladding products

4.5 PHYSICAL PROPERTIES

4.5.1 Density

ThermoWood® has a lower density than unmodified wood. This is mainly the result of wood losing some of the compounds in it during thermal modification.

Figure 22 shows the impact of thermal modification on the density of pine when it is treated for three hours at temperatures of +160 to +240°C. The density decreases as higher temperatures are

used. However, deviation is high and the coefficient of determination is low, due to natural variation in wood density. The average density at temperatures of <160°C is 560 kg/m³. The test material was conditioned at a relative humidity of 65%. Table 5 presents the results of a more extensive study.

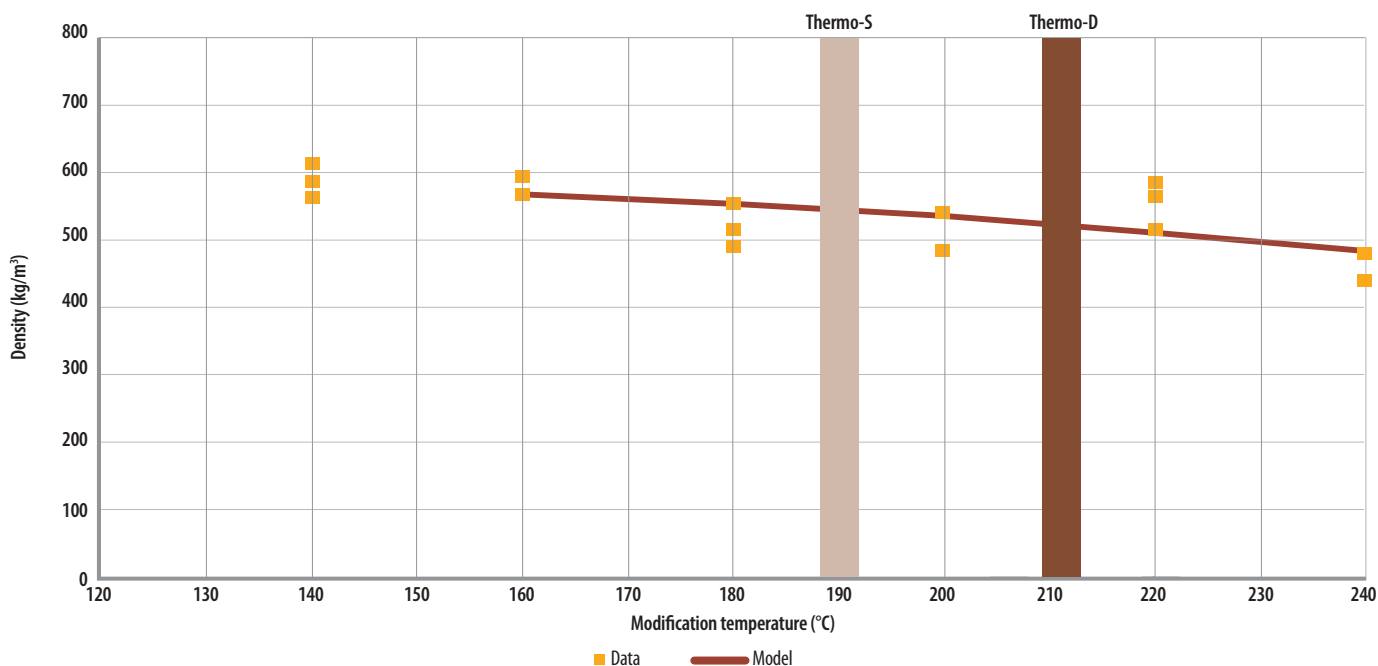


Figure 22. The impact of the modification temperature on the density of ThermoWood® (source: VTT).

Table 5. Density of ThermoWood® (the average of measurements).

Species	Product	Quantity [pcs]	Dry density (air-dried) [kg/m ³]	Dry density (air-dried) 20°C/65% RH [kg/m ³]	Dry density (kiln-dried) [kg/m ³]
Pine	Reference	-	490	-	-
	Thermo-S	18	430	-	-
	Thermo-D	18	420	-	-
Spruce	Reference	-	460	-	-
	Thermo-S	20	430	-	-
	Thermo-D	19	420	-	-
Ash	Reference	-	-	625	-
	Thermo-S	-	-	560	-
	Thermo-D	-	-	554	-
	Thermo-220°C	-	-	526	-
Ayous	Thermo-S	-	-	392	357
	Thermo-D	-	-	353	339
Frake	Thermo-S	-	-	573	553
	Thermo-D	-	-	537	339

4.5.2 Bending strength and modulus of elasticity

In general, the strength of wood material has a strong correlation with its density. Because thermally modified timber has slightly lower density, its strength values remain below those of standard timber in some cases. Currently, ThermoWood® products are not available as strength-graded timber and it must not be used for load-bearing structures.

Substantial strength loss in pine starts at temperatures higher than 220°C. However, thermal modification of timber does not significantly change its modulus of elasticity. Pine with an average density of 560 kg/m³ was used as the test material. Two methods for testing bending strength were used in the study. In one of the methods, defect-free material over a short span is used while in the other, pieces with natural defects over a longer span are used. Table 6 presents the results of a more extensive study.

Figure 23 shows the impact of thermal modification on pine's bending strength and Figure 24 shows its impact on the modulus of elas-

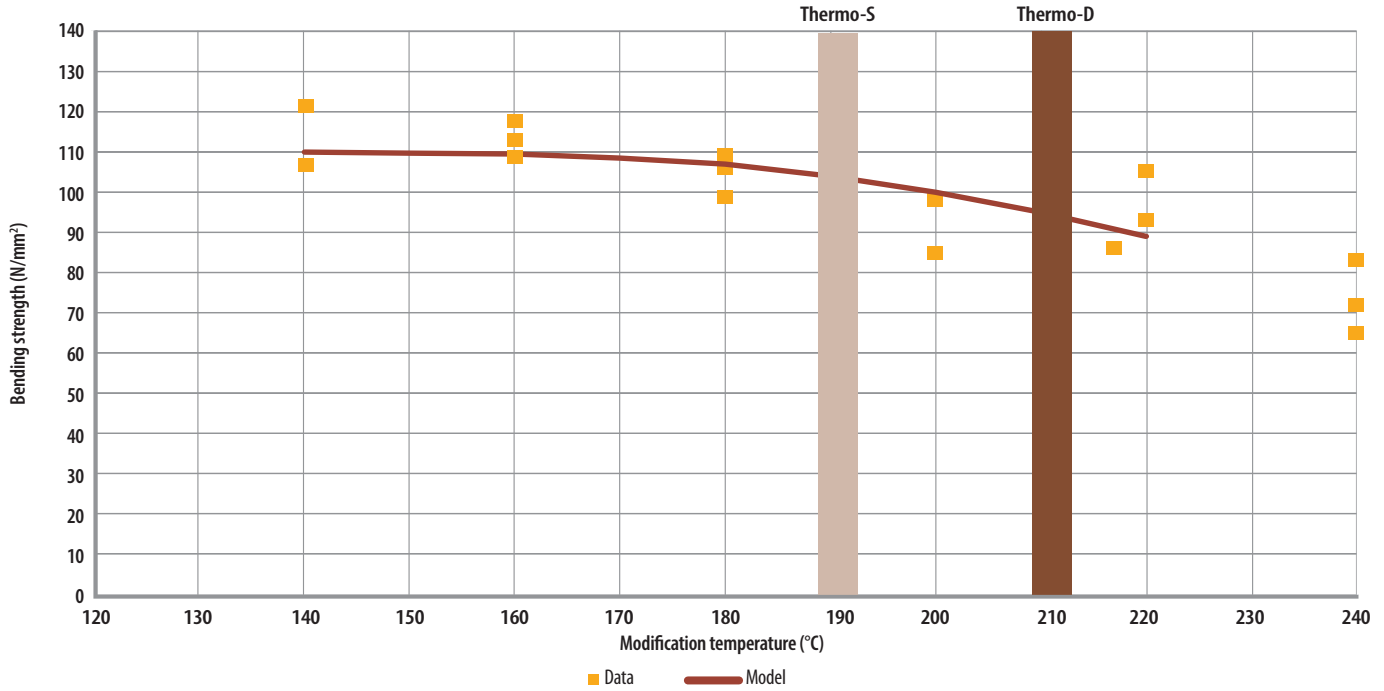


Figure 23. The impact of the modification temperature on the bending strength of ThermoWood® (source: VTT).

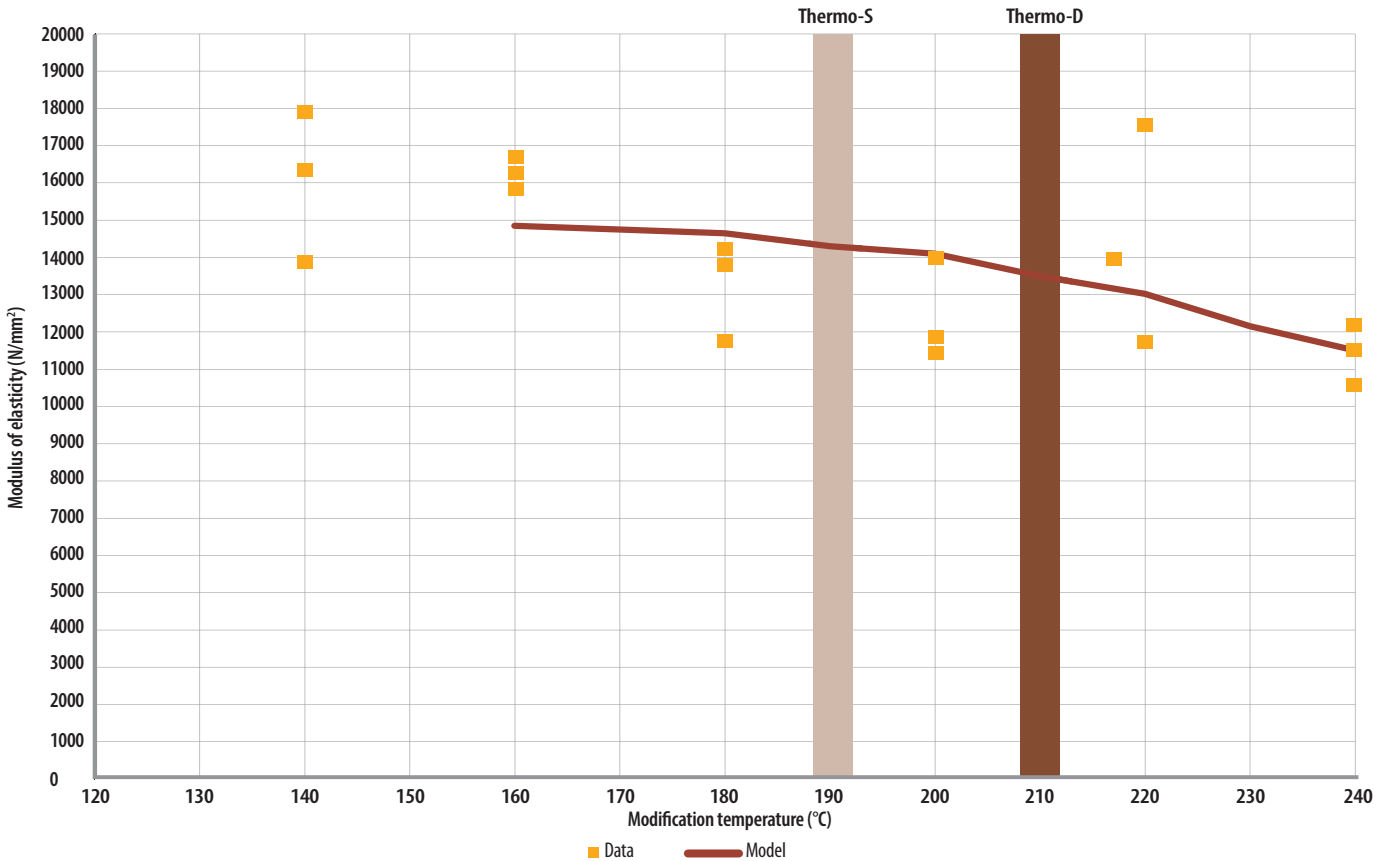


Figure 24. The impact of the modification temperature on the modulus of elasticity of ThermoWood® (source: VTT).

Table 6. Bending strength and modulus of elasticity of ThermoWood® (the average of measurement results).

Species	Product	Quantity [pcs]	Dry density (air-dried) [kg/m³]	Dry density (air-dried) 20°C/65% RH [kg/m³]	Dry density (kiln-dried) [kg/m³]
Pine	Reference	-	EN 408	60.7	9,274
	Thermo-S	-	EN 408	45.1	9,006
	Thermo-D	-	EN 408	38.1	9,262
Spruce	Reference	-	EN 408	74.2	13,658
	Thermo-S	-	EN 408	65.0	11,197
	Thermo-D	-	EN 408	47.5	10,133
Ash	Reference	20 x 20 x 360	DIN 52186	112.0	12,056
	Thermo-S	20 x 20 x 360	DIN 52186	106.9	13,559
	Thermo-D	20 x 20 x 360	DIN 52186	90.6	13,320
	Thermo-220°C	20 x 20 x 360	DIN 52186	75.9	12,848
Ayous	Thermo-S	100 x 40 x 2,000	EN 408	28.1	7,414
	Thermo-D	150 x 40 x 3,000	EN 408	27.6	7,338
Frake	Thermo-S	100 x 40 x 2,000	EN 408	61.1	14,607
	Thermo-D	100 x 40 x 3,000	EN 408	54.7	14,880

4.5.3 Screw holding strength

According to studies, the general variation in wood density has greater impact on the screw holding strength than by thermal modification. In lower-density material, the results were better

when smaller, pre-drilled holes were used. Research results on screw holding strength are presented in Tables 7 and 8.

Table 7. Screw holding strength in ThermoWood® (the average of measurements).

Species	Product	Standard	Screw holding strength [N/mm²]
Pine	Reference	EN 1382	22.24
	Thermo-S	EN 1382	20.04
	Thermo-D	EN 1382	19.56
Spruce	Reference	EN 1382	22.01
	Thermo-S	EN 1382	18.20
	Thermo-D	EN 1382	14.92

Table 8. Screw holding strength in ThermoWood® cladding products (the average of measurements).

Species	Product	Standard	Screw size Penetration depth tpen	Screw holding strength	
				Direction of radius [N/mm²]	Direction of tangent [N/mm²]
Ayous	Thermo-S	EN 1382	Screw 3.0x38 tpen = 24 mm	13.56	13.62
		EN 1382	Screw 4.0x72 tpen = 32 mm	11.64	10.84
	Thermo-D	EN 1382	Screw 3.0x38 tpen = 24 mm	10.44	11.17
		EN 1382	Screw 4.0x72 tpen = 32 mm	9.28	9.00
Frake	Thermo-S	EN 1382	Screw 3.0x38 tpen = 24 mm	33.97	33.82
		EN 1382	Screw 4.0x72 tpen = 32 mm	27.95	27.60
	Thermo-D	EN 1382	Screw 3.0x38 tpen = 24 mm	32.28	33.77
		EN 1382	Screw 4.0x72 tpen = 32 mm	28.80	28.93

4.5.4 Compression strength perpendicular to the grain

According to tests conducted with timber modified at 195°C for 3 hours, the compression strength parallel to the grain of thermally modified timber is about 30% higher than that of standard timber. Prior to testing, the test pieces were submerged in water.

4.5.5 Compression strength parallel to the grain

According to studies, thermal modification does not reduce wood's compression strength parallel to the grain. Research results indicate that the compression strength parallel to the grain of thermally modified timber is higher than that of standard timber. This also applies to timber modified at higher temperatures (Figure 25). Compression strength is mainly dependent on density.

Tests have shown that under compression parallel to the wood grain, test pieces break into smaller sections but, unlike with standard timber, they do not buckle. This is because thermally modified timber is not as elastic as untreated timber.

4.5.6 Impact bending strength (dynamic bending)

Studies indicate that thermal modification reduces impact strength, compared with standard timber. Tests with spruce modified at 220°C for three hours showed that the impact strength was reduced by about 25%, compared with untreated wood.

4.5.7 Shear strength

In tests, modification at a high temperature (230°C for 4 hours) resulted in a reduction of 1–25% in shear strength in radial tests and in a reduction of 1–40% in tangential tests, compared with untreated wood. However, modification at a lower temperature (190°C) had very little effect on pine, although spruce showed a 1–20% decrease in both radial and tangential tests.

4.5.8 Splitting strength

Studies have indicated that thermal modification reduces splitting strength by 30–40%. Spruce, pine and birch along with an extensive range of modification temperatures were used in these studies. The drop in splitting strength is greater when higher temperatures are used.

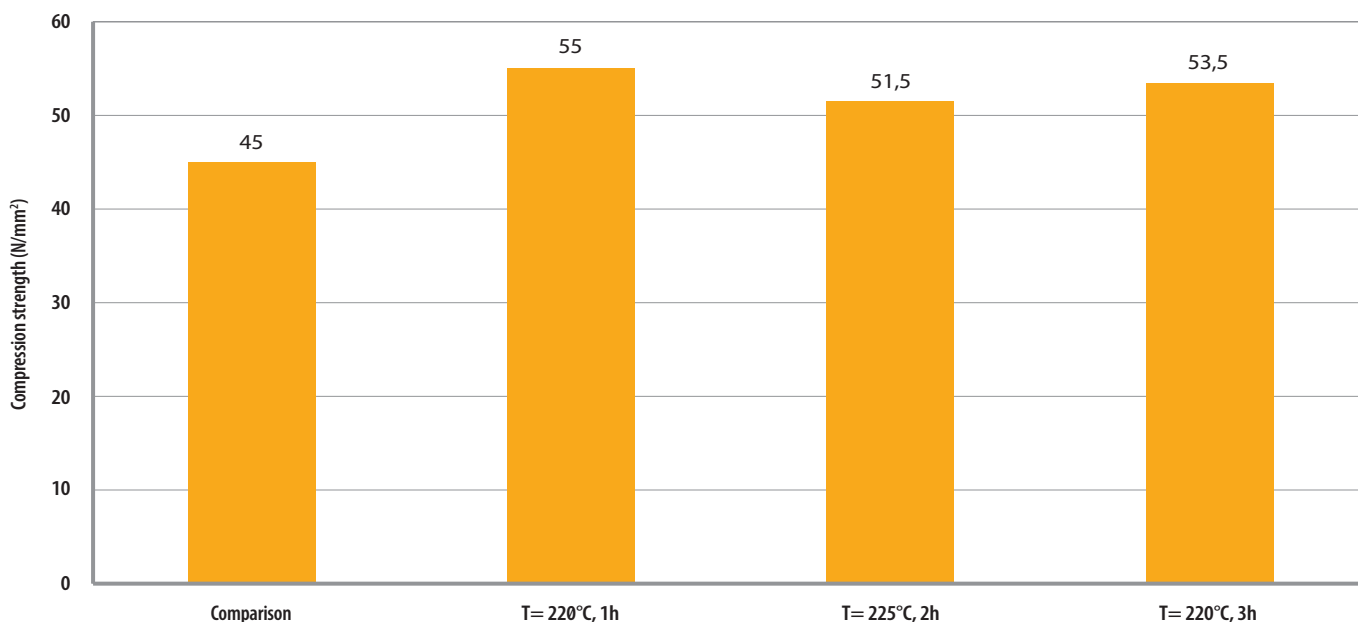


Figure 25. Compression strength parallel to the grain of thermally modified spruce (average density 420 kg/m³) (source: VTT).

4.5.9 Hardness

Figure 26 shows that Brinell hardness increases as the modification temperature goes up. However, studies have indicated that the relative change is very small and has no practical impact. For all wood

species, Brinell hardness is to a large extent dependent on density. Table 9 presents results of a more extensive study.

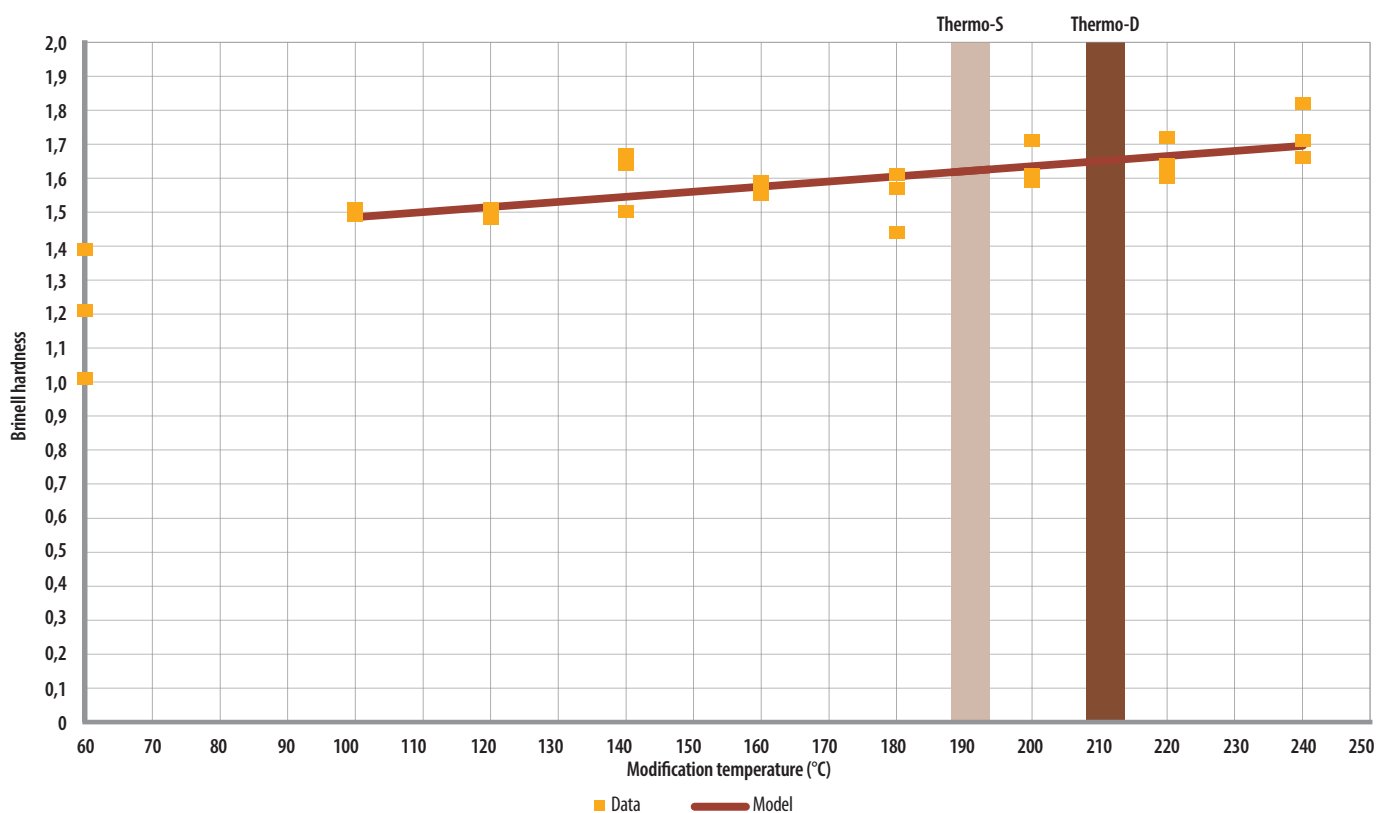


Figure 26. The impact of thermal modification (3 h) on Brinell hardness of pine (source: VTT).

Table 9. Brinell hardness of ThermoWood® (the average of measurements)

Species	Product	Dimensions [mm]	Brinell hardness [N/mm ²]				
			EN 1534 Spherical lpm 10 mm F = 981 N	EN 1534 Spherical lpm 20 mm F = 1,000 N Direction of radius	EN 1534 Spherical lpm 20 mm F = 1,000 N Direction of tangent	EN 1534 Spherical lpm 10 mm F = 500 N Direction of radius	EN 1534 Spherical lpm 10 mm F = 500 N Direction of tangent
Pine	Reference	-	1.62	-	-	-	-
	Thermo-S	-	1.67	-	-	-	-
	Thermo-D	-	1.40	-	-	-	-
Spruce	Reference	-	1.66	-	-	-	-
	Thermo-S	-	1.55	-	-	-	-
	Thermo-D	-	1.52	-	-	-	-
Ash	Reference	20 x 20 x 300	-	35.13	35.33	-	-
	Thermo-S	20 x 20 x 300	-	30.92	29.27	-	-
	Thermo-D	20 x 20 x 300	-	27.75	27.56	-	-
	Thermo-220°C	20 x 20 x 300	-	25.59	23.27	-	-
Ayous	Thermo-S	40 x 40 x 300	-	-	-	9.83	9.00
	Thermo-D	40 x 40 x 300	-	-	-	8.83	7.98
Frake	Thermo-S	40 x 40 x 300	-	-	-	26.39	23.70
	Thermo-D	40 x 40 x 300	-	-	-	27.35	24.06

4.5.10 Fire resistance

Compared with standard timber, ThermoWood® causes a smaller fire load and its smoke production is lower. This is due to the lower density of ThermoWood® and its lower levels of wood constituents and extractives. In addition, better sealing can be achieved with ThermoWood® for the cladding in fire technical terms because less shrinkage arises as a result of changes in moisture levels.

The above-mentioned factors may not be directly utilised in fire technical design, and application-specific planning must be carried out with fire technical simulation programs, for example.

4.6 THERMOMECHANICAL PROPERTIES

4.6.1 Equilibrium moisture content

Thermal modification reduces timber's equilibrium moisture content. Figure 27 shows the impact of thermal modification on the equilibrium moisture content of spruce. At high temperatures (220°C), the equilibrium moisture content is halved compared with untreated spruce. With a higher relative humidity, the difference in wood moisture values is larger.

Saprotrophic fungi become active when the timber's moisture content exceeds 20%. Irrespective of the air's relative humidity, the equilibrium moisture content of thermally modified timber remains significantly below 20%. This has a huge impact on the timber's long-term durability.

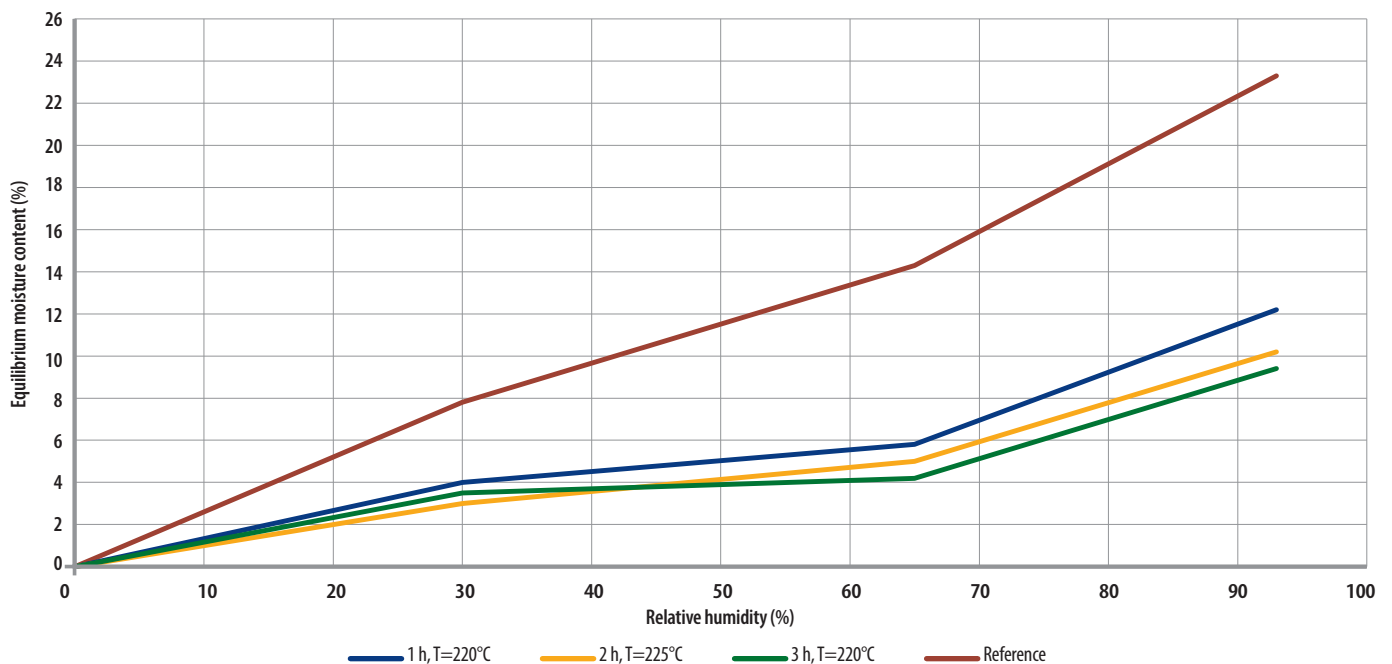


Figure 27. The impact of relative humidity on the equilibrium moisture content of thermally modified spruce (source: VTT).

4.6.2 Swelling and shrinkage due to moisture

The decreased equilibrium moisture content of ThermoWood® affects its swelling and shrinkage due to moisture. Thermal modification significantly reduces the tangential and radial swelling of timber. Figures 28 and 29 show how thermal modification decreases the swelling of thermally modified timber compared

with standard timber. Thanks to reduced swelling and shrinkage, ThermoWood® is more dimensionally stable than standard timber. It retains its dimensions well, even without surface treatment.

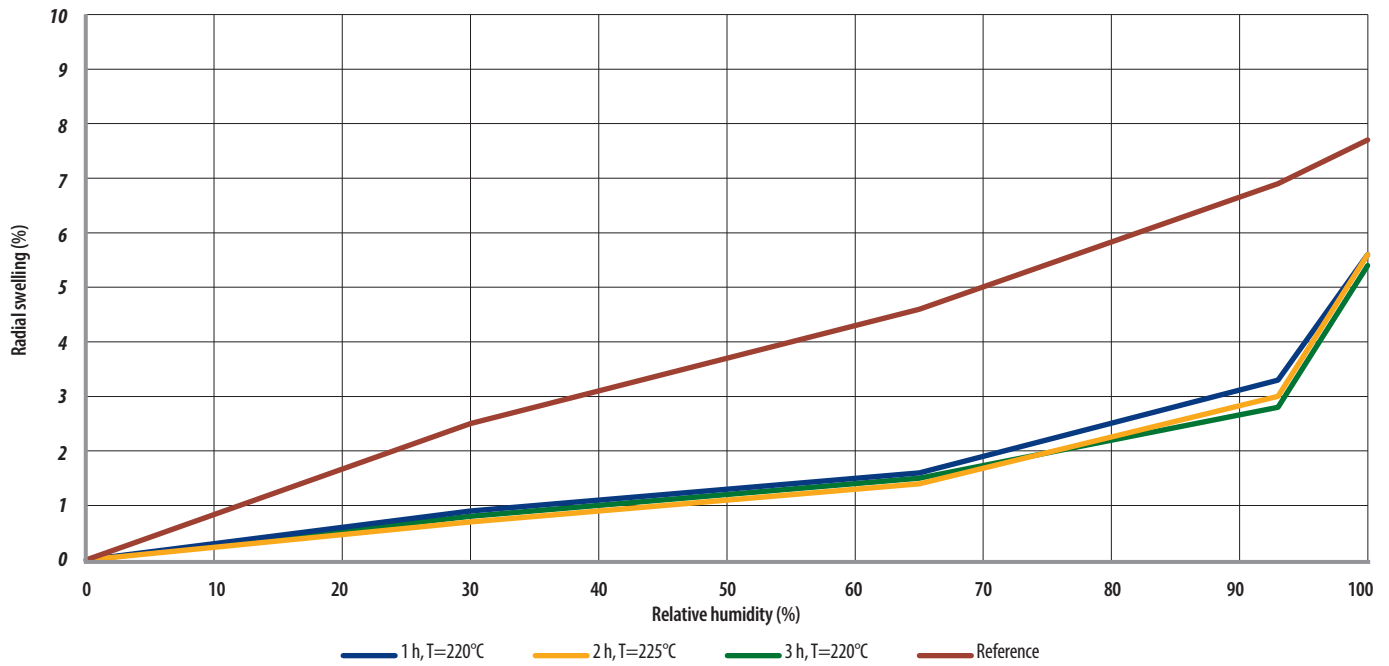


Figure 28. Radial swelling of spruce as a function of relative humidity (source: VTT).

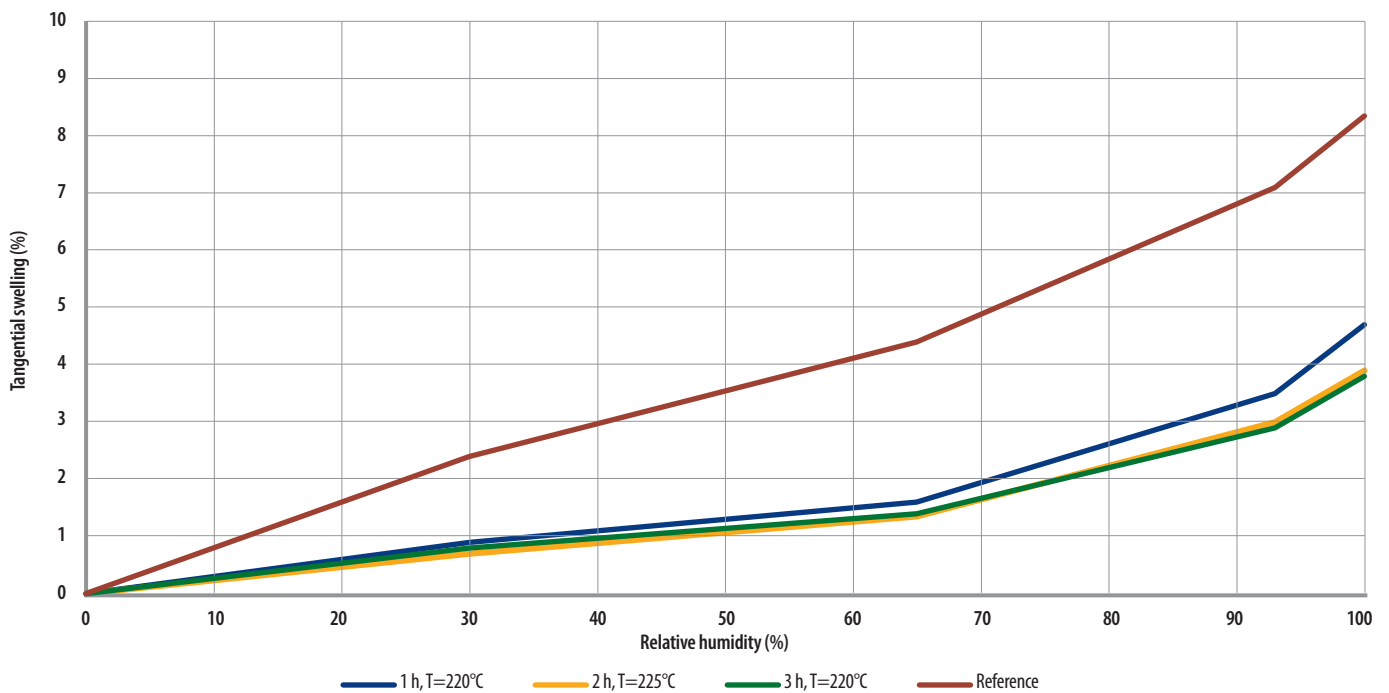


Figure 29. Tangential swelling of spruce as a function of relative humidity (source: VTT).

4.6.3 Permeability

The water permeability of ThermoWood® has been tested with regard to end grain penetration. This property is important in windows, for example. First, the test pieces were submerged in demineralised water. They were then kept in a room with a relative humidity of 65% and a temperature of 20°C and weighed at regular intervals over a period of nine days. The results indicated that over a short period, the water permeability of thermally modified spruce is 20–30% lower than that of corresponding untreated timber.

In another study, permeability was tested by soaking the pieces in water for 72 hours with their end surfaces sealed. According to the results, the moisture content of untreated spruce was 22%, 12% for timber modified at 195°C and 10% for timber modified at 210°C.

Thermal modification reduces timber's permeability to steam. Figure 25 shows how thermal modification decreases the permeability to steam of ThermoWood® spruce compared with standard timber.

4.6.4 Thermal conductivity

Studies indicate that thermal modification reduces thermal conductivity, compared with standard timber. The thermal conductivity of thermally modified Nordic softwood is 20–25% lower than that of standard timber. Because of this, ThermoWood® makes an ideal material for structures such as exterior doors, exterior cladding, windows and saunas.

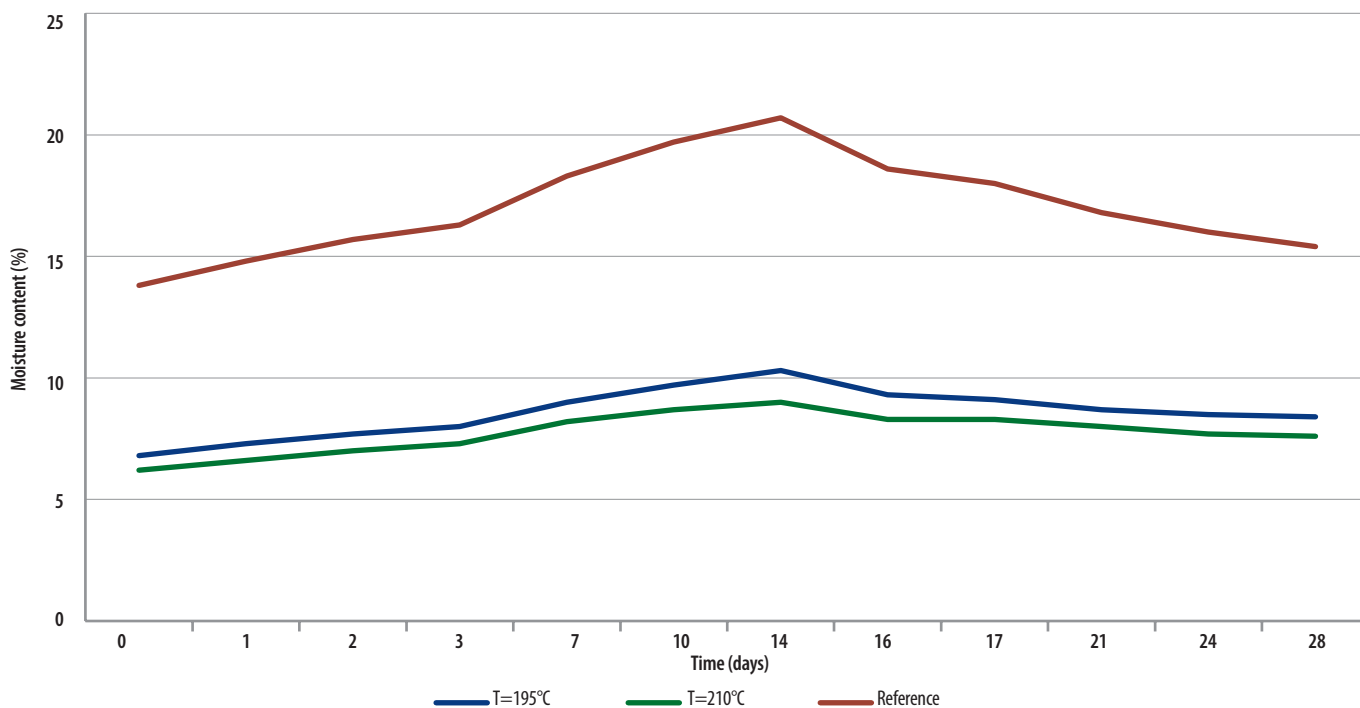


Figure 30. The impact of thermal modification on steam permeability Spruce (source: VTT)

4.7 LONG-TERM DURABILITY

4.7.1 Weather resistance

When exposed to weather without surface treatment, ThermoWood® products remain significantly drier than unmodified timber. However, surface treatment that protects against humidity, erosion and UV radiation is recommended for thermally modified timber that is exposed to weather conditions. The recommendation particularly applies to applications in warm and humid climates.

Due to rain, a slight change in the original colour in untreated thermally modified timber is possible. UV radiation causes greying of wood products that are without surface treatment.

As happens with all materials exposed to rain, mould may also appear on the surface of thermally modified timber. Because of airborne bacteria or impurities in rain, mould may occur on untreated surfaces. However, this growth is superficial and can be removed by wiping or scraping the surface.

The timber's natural resistance (without surface treatment) is determined with laboratory tests pursuant to standards. Table 10 presents applications of thermally modified timber. It is not recommended for structures that come into direct contact with soil or water.

4.7.2 Biological resistance

As is the case with all materials exposed to rain, mould may also appear on the surface of ThermoWood®. Because of airborne bacteria or impurities in rain, mould may occur on untreated surfaces. However, this growth is superficial and can be removed by wiping or scraping the surface.

The timber's natural resistance (without surface treatment) is determined by laboratory tests pursuant to standards. Table 10 presents applications of ThermoWood®. It is not recommended for structures that come into direct contact with soil or water.

Table 10. The suitability of ThermoWood® products for various applications

Durability class (EN 350)	Use class (EN 335)	Examples of applications	ThermoWood® products
1 = Very durable	5 = Exposed to seawater 4 = Water contact	-	-
2 = Durable	3 = Outdoors, exposed to weather	Outdoor cladding Garden structures	Thermo-D, pine, spruce Thermo-D, ash, ayous, frake
3 = Moderately durable	2 = Outdoors, under roof	Sauna structures Outdoor structures and furniture under roof	Thermo-S, pine, spruce Thermo-S, hardwoods Thermo-D, hardwoods
4 = Little durable	1 = Indoors in dry conditions	Interior cladding	-

4.7.3 Resistance to insects

Longhorn beetles are found in the sapwood of softwoods. The common furniture beetle (*Anobium punctatum*) attacks particularly hardwoods. *Lyctus Bruneus* is found in some hardwood species. Studies have shown that ThermoWood® is resistant to all three insects. ThermoWood® offers good resistance to longhorn beetles. These beetles identify pine as a suitable place for laying eggs because of the terpene it emits. The amounts of terpene produced by ThermoWood® are drastically reduced in comparison with untreated wood. Because of this, it is expected that beetles will choose other wood materials over ThermoWood®, whenever possible. Studies indicate that this also applies to termites. However, further studies on this are required.

Studies carried out to date do not prove that ThermoWood® is resistant to termites. Termites enter building structures from the earth below, avoiding direct sunlight whenever possible. Termites attack both wood and concrete-based materials when looking for food. A number of measures have been developed to tackle the problem, including the installation of polythene membranes in building foundations. Also, various bituminous paint products are available, which can be used to seal possible routes into the building. However, local tests are recommended because termite types vary from one region to another. More research data on termite behaviour is also required.

4.8 IMPACT ON INDOOR AIR QUALITY

Similarly to standard timber, ThermoWood® is hygroscopic and levels out fluctuations in the humidity of indoor air. However, with ThermoWood®, this effect is smaller because of reduced equilibrium moisture content. It should also be noted that with both ThermoWood® and standard timber, the type of surface treatment applied has a significant impact on this phenomenon. Treatment that seals the timber too effectively prevents the transfer of moisture between the indoor air and the wood product.

Thermally modified timber emits a smoky fragrance, probably arising from chemical compounds called furfurals. Even though the fragrance is clearly detectable by human senses and it seems stronger than the fragrance of standard timber, the amount of volatile organic compounds (VOC) emitted by thermally modified timber is only a fraction of those from standard pine.

Emission levels have been measured from ThermoWood® pine. The samples were kept at temperatures of 180°C and 230°C for 4 hours. Measurements were taken 7 (180°C) or 8 weeks (230°C) after the modification. At 1,486 µg/m²h, the emission levels of volatile organic compounds from unmodified pine were the highest. The majority of these emissions consisted of terpenes, but significant amounts of alpha-pinene, camphene and limonene were also detected. In addition, untreated pine contained hexanal and small amounts of furfural and acetic acid. The total level of emissions from pine modified at +180°C was 828 µg/m²h. The sample contained terpenes, furfurals, hexanal and acetic acid. At 235 µg/m²h, the total emission level of pine modified at +230°C was the lowest. Acetic acid accounted for the majority of the total emissions (110 µg/m²h). The sample also contained small amounts of terpenes. As can be seen from Figure 31, ThermoWood® is a safe choice for indoor applications in terms of its emission levels.

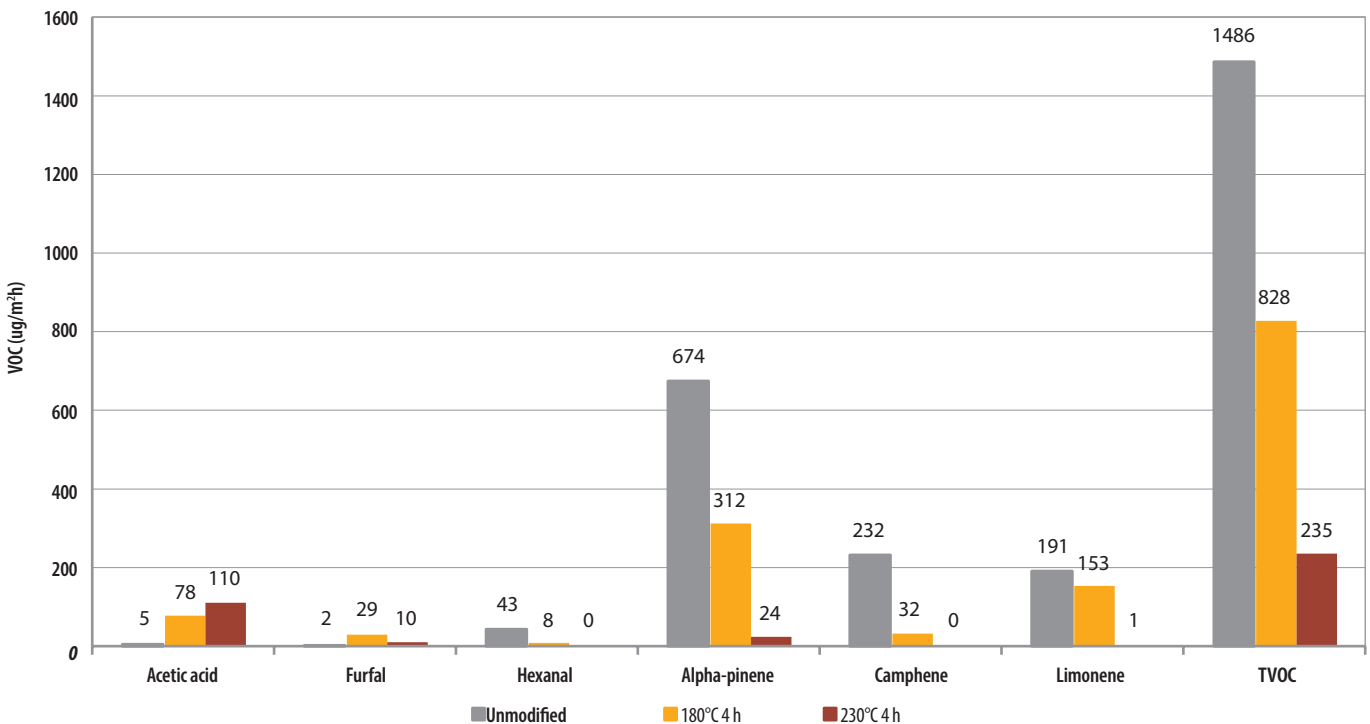


Figure 31. Volatile organic compounds emitted by pine samples after two months (source: VTT).

5

PROCESSING OF ThermoWood® PRODUCTS

In general, the handling of ThermoWood® requires a little more care than the handling of unmodified wood, as it is more susceptible to mechanical damage because of its strength properties.

As ThermoWood® does not secrete resin, saw blades require less maintenance.

Dust generated in the processing of ThermoWood® is dry and fine and therefore special attention should be paid to the efficacy and air-tightness of the dust removal system. A respirator must be used when working with ThermoWood® if dust is generated.

Prior to the commencement of work, the timber's moisture content should be checked to ensure that it matches the humidity of the location. Depending on the size of the cross-section, conditioning at room temperature may take several days. In outdoor conditions, it may take weeks or even months, particularly in winter. This must be factored in when work schedules are being prepared.

5.1 SAWING

The sawing of ThermoWood® does not differ from working with untreated wood. Since saw blades with large teeth can cause chipping on the edges of ThermoWood®, fine-toothed blades are recommended.

5.2 PLANING

Similarly to any other timber, cupping may occur in ThermoWood®. Because of cupping, the use of narrow infeed rollers is recommended to reduce the risk of cracking of the wood surface being worked on.

With the convex face of the timber facing down, a single narrow wheel positioned in the centre of the piece can be used. Two narrow wheels positioned on the edges of the piece must be used if the timber is placed with the convex face up.

These options are illustrated in Figure 32. To prevent cracking, the infeed roller pressure must be set lower than with untreated timber. This is due to the reduction in strength in the ThermoWood®.

In real-life settings, it has been noted that because no resin is secreted, less friction occurs in the infeed of ThermoWood®, helping planing to proceed more smoothly. On some planing lines, speed must be reduced. The roller pressure and speed and other parameters are dependent on the properties of the planing line and machine. When ThermoWood® is planed, parameters must be set separately for each product and machine.

To achieve the best possible planing results and to minimise the loosening of the wood's annual rings, we recommend using material that has been cut as parallel to the grain as possible. In addition, selecting the best face of the board when planing improves the result. There is a close connection between the infeed roller type and pressure, the grain direction, cupping, cutter sharpness and throughput speed.

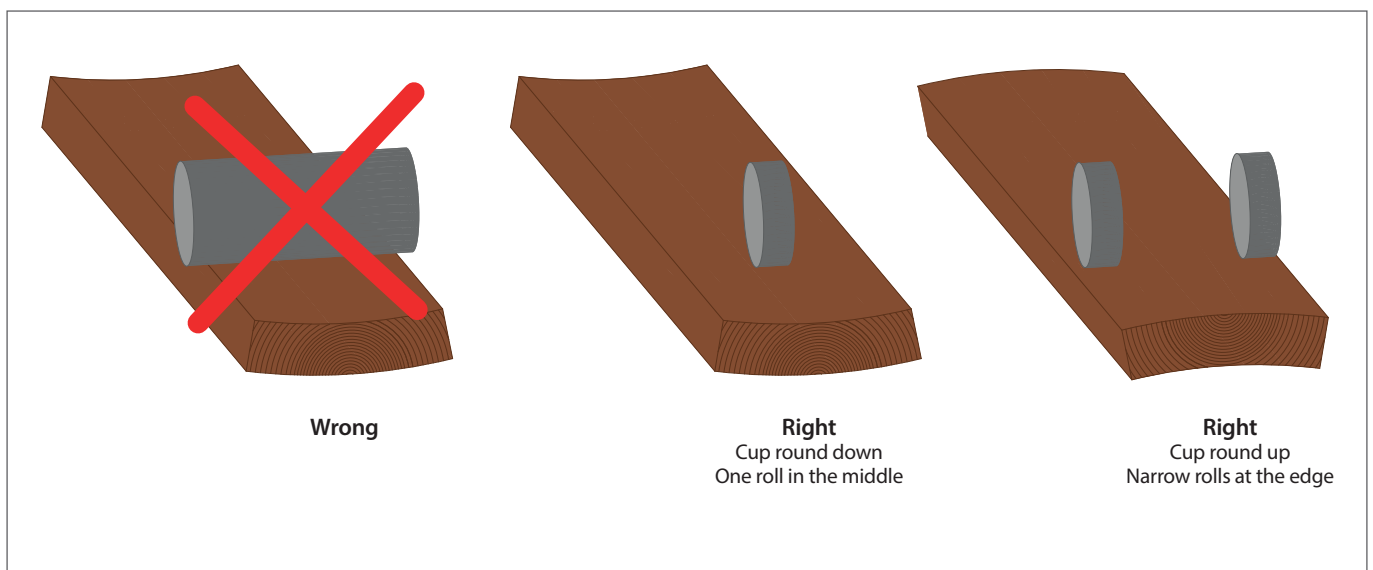


Figure 32. Narrow plane infeed rollers must be used with ThermoWood® products.

5.3 MILLING

Milling ThermoWood® resembles working with hard, brittle hardwoods. Milling must be planned carefully in advance to avoid tears and nicks, particularly when milling against the grain.

5.4 SANDING

Sanding ThermoWood® products does not differ from sanding standard timber. Typically, no sanding is required because the surface quality of ThermoWood® is usually very good after planing.

5.5 GLUING

The gluing properties of ThermoWood® have been tested with 1- and 2-component PVAc adhesives, 1- and 2-component polyurethane adhesives (PU), resorcinolphenol adhesives (RF) and emulsion-polymer-isocyanate adhesives (EPI).

With PVAc adhesives, the water content in the adhesive should be minimised. These adhesives may require longer pressing and drying times with ThermoWood® because of the reduced absorption rate of water into the timber (the adhesive takes longer to harden).

When PU adhesives are used, it should be noted that the curing process requires water. Water can be absorbed from either the timber being glued or the surrounding air. When necessary, the surfaces being glued must be dampened.

RF and EPI adhesives have also been found to be effective with ThermoWood®. In tests, RF adhesives worked with normal production parameters for ThermoWood®.

When gluing ThermoWood®, or any other wood, attention should be paid to factors such as the temperature and moisture content of the wood and the cleanliness of its surface. The adhesive manufacturer's instructions should be complied with in the choice and use of an adhesive.

ThermoWood® is also used to produce glued products. Instructions are manufacturer-specific and more detailed information on the products are available in the instructions provided by the manufacturer.



Figure 33. ThermoWood® glue beams in pergola structure

6

SURFACE TREATMENT OF ThermoWood® PRODUCTS

6.1 THERMOWOOD® AS A BASIS FOR SURFACE TREATMENT

ThermoWood® makes an excellent basis for surface treatment agents because it is resin-free and it only swells and shrinks to a small degree when exposed to moisture. Therefore paint or any other coating applied to it does not crack. In the surface treatment of ThermoWood®, it should be noted that all surface treatment agents do not sufficiently adhere to the surface because of the acidity and low water absorbance capacity of ThermoWood®. This is the case particularly with some water-based surface treatment agents. The roughness of the surface may also have an impact on adherence. For example, surfaces sanded with P100 sandpaper may be better in terms of adherence than planed surfaces. Brushed surfaces have also been shown to work well with surface treatment agents. If the surface is too rough (sawn surface), the surface treatment may be more difficult because of splinters.

6.2 THE MOST COMMONLY USED SURFACE TREATMENT AGENTS

ThermoWood® can be treated with agents similar to those used with standard timber (including paint, lacquer, oil and wax). ThermoWood® can be treated with both water- and solvent-based surface treatment agents. However, linseed oil is not suitable for ThermoWood® because it enables fungal growth.

Surface treatment is recommended for ThermoWood® products that are exposed to weather. Surface treatment helps retain the original colour and reduce cracking and splintering that are typical of wood materials over time. Mineral oil is recommended for interior walls, ceilings and benches in saunas.

Industrial surface treatment is recommended for ThermoWood® as well as for other timber products. This ensures that the surface treatment is carried out in controlled conditions with suitable treatment agents, guaranteeing the high quality and durability of the surface treatment.

6.3 PERFORMANCE OF SURFACE TREATMENT

When treating ThermoWood®, or any other timber, attention must be paid to the choice of correct surface treatment and its maintenance. With regard to this, we recommend contacting manufacturers of surface treatment agents. Before surface treatment, steps should be taken to ensure that UV radiation and humidity do not cause micro cracks on the surface of the product as these may affect the success of the surface treatment.

The cut ends of any timber, including ThermoWood®, should be sealed with end grain sealer designed for the purpose. This significantly decreases the absorption of water via the cut ends and reduces cracking near the ends caused by drying.

6.4 FIRE PROTECTION TREATMENT

Like all timber, ThermoWood® products can be treated with fire-retardant agents. The fire-retardant agents should be checked to ensure that they have the required approvals and they should always be used in compliance with the manufacturer's instructions. With fire-retardant treatment, ThermoWood® can meet the requirements of fire protection class C or B, depending on the agent used. The highest classification that can be achieved is B-s1, d0. ThermoWood® products are also available with ready-applied fire retardant treatment.

7

PROCUREMENT AND STORAGE OF ThermoWood® PRODUCTS

ThermoWood® products are available from timber retailers and hardware stores that stock other timber products. The stocked products vary depending on the retailer, and special products must be ordered separately.

The following factors must be taken into account in the storage of ThermoWood®:

- A dry ventilated storage space must be used (a dry outdoor space can be used for products for outdoor applications)
- Products to be used for indoor applications must be stored in a heated indoor space
- Products must be protected against dirt and UV radiation
- They must be placed in a horizontal position on an even base (off the ground)
- A sufficient number of battens must be used as the base
- Product bundles must not be loosened before use
- Interior cladding products are used directly from the package
- When lifting long products, bear in mind their reduced bending strength
- Products with a tongue-and-groove finish must be handled with care to avoid damage (particularly with long products)

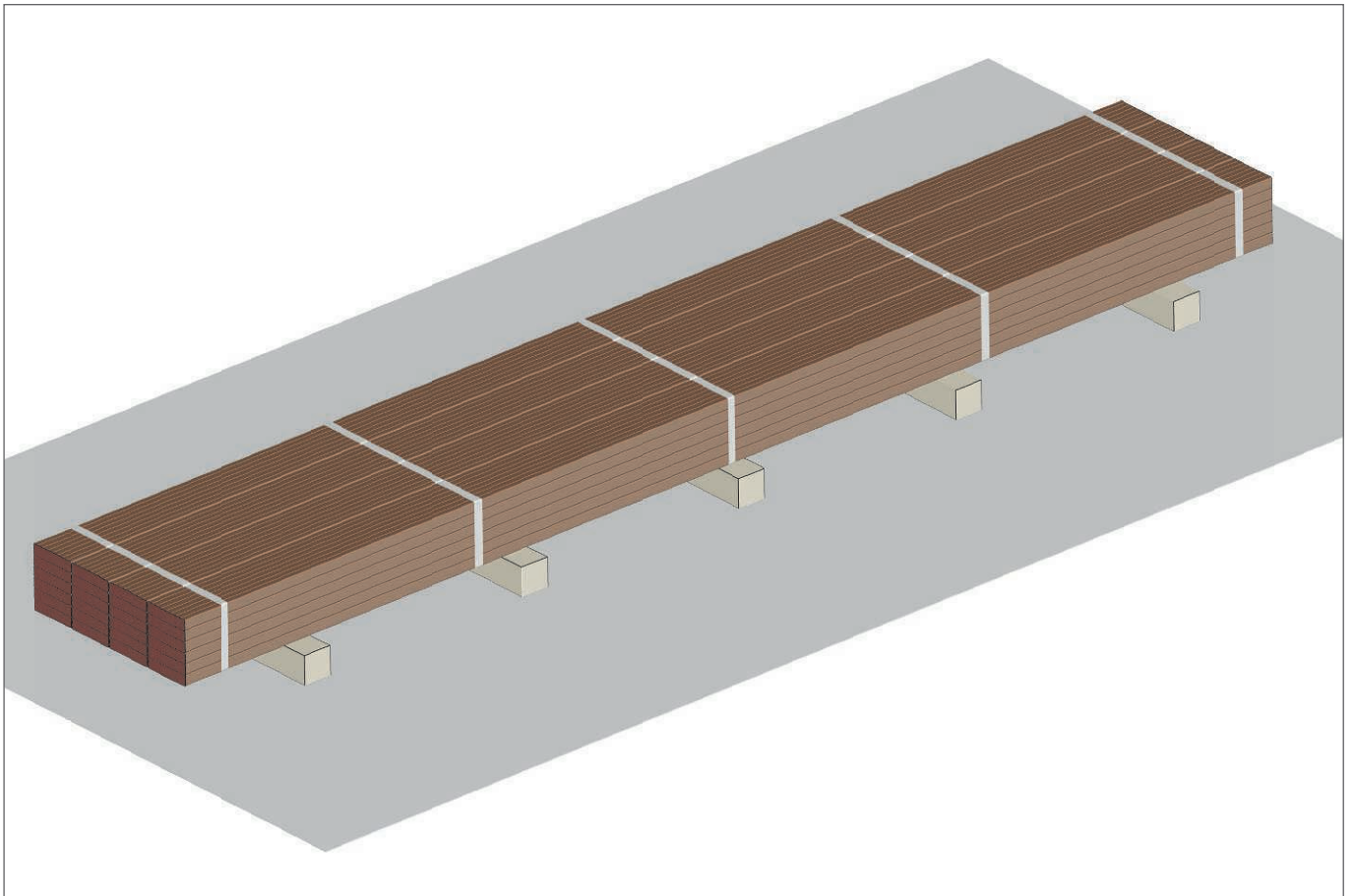


Figure 34. An even surface and a sufficient number of base battens prevent the products from warping.

8

CONSTRUCTION INDUSTRY APPLICATIONS OF ThermoWood® PRODUCTS

ThermoWood® intended for house construction applications typically includes cladding materials for indoor and outdoor use and products for the carpentry industry. In garden construction, ThermoWood® is typically used for patios, fences and garden furniture. The same products can be used indoors and outdoors.

8.1 INDOOR USE

ThermoWood® shows less shrinkage and swelling due to changes in humidity than standard timber, which reduces the formation of gaps that is otherwise typical of wooden floors. This property is particularly evident in spaces where fluctuations in indoor humidity are pronounced. Flooring material made of ThermoWood® is also available with tongue-and-groove ends. The tongue-and-groove joint must be positioned on top of a frame board if a load-bearing flooring base is not installed (e.g. plywood sheets).

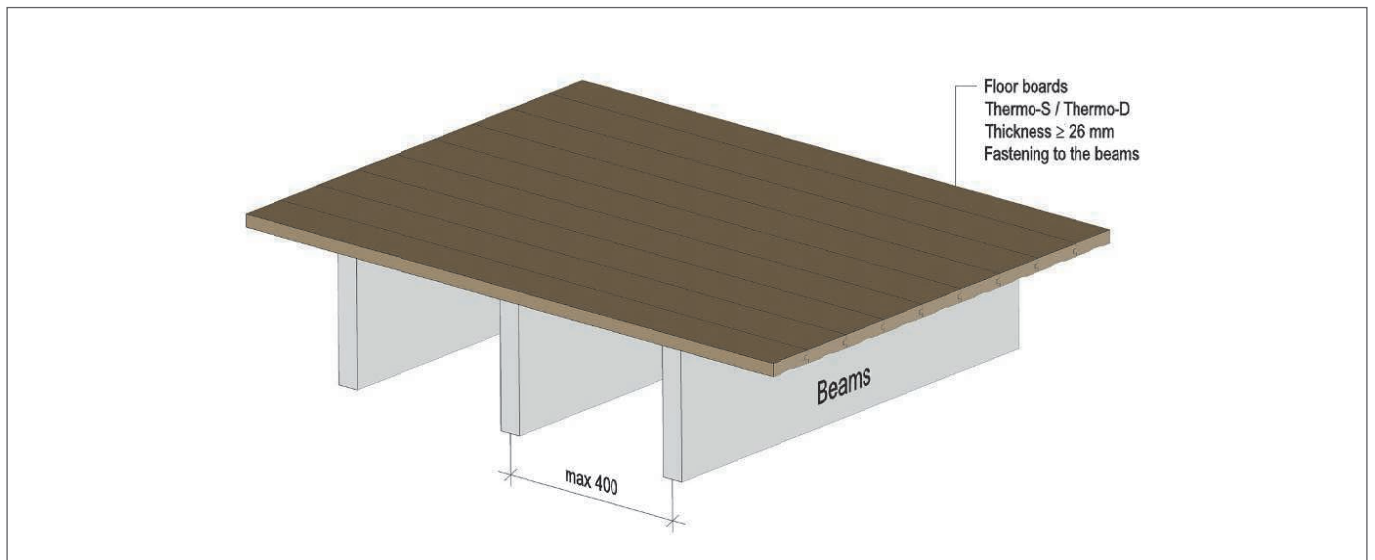


Figure 35. An example of flooring.

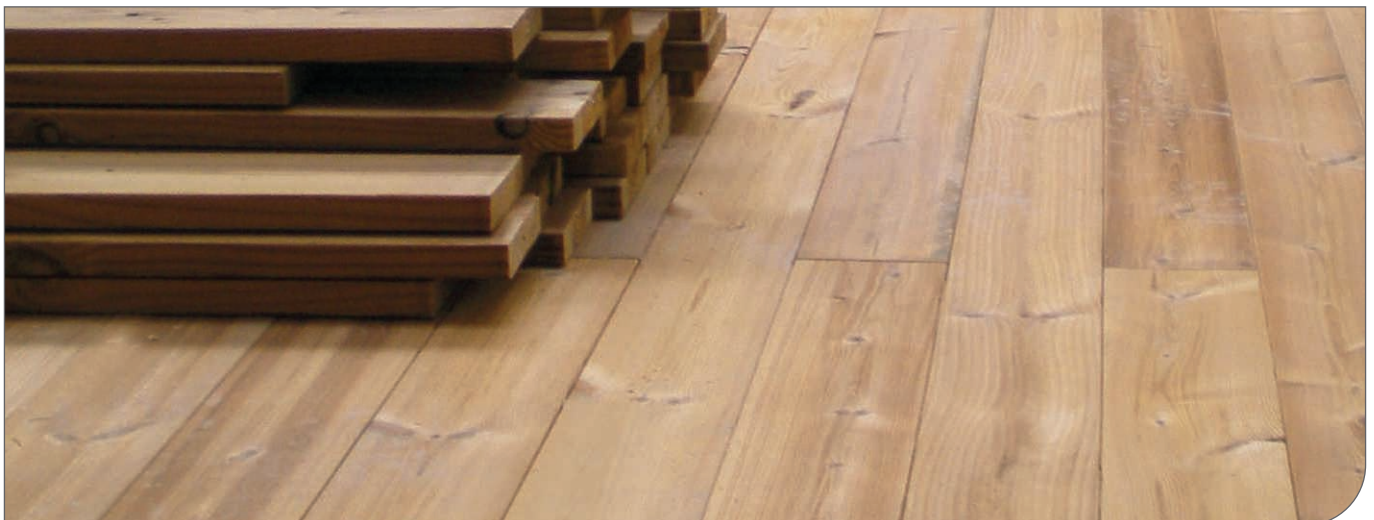


Figure 36. ThermoWood® flooring.

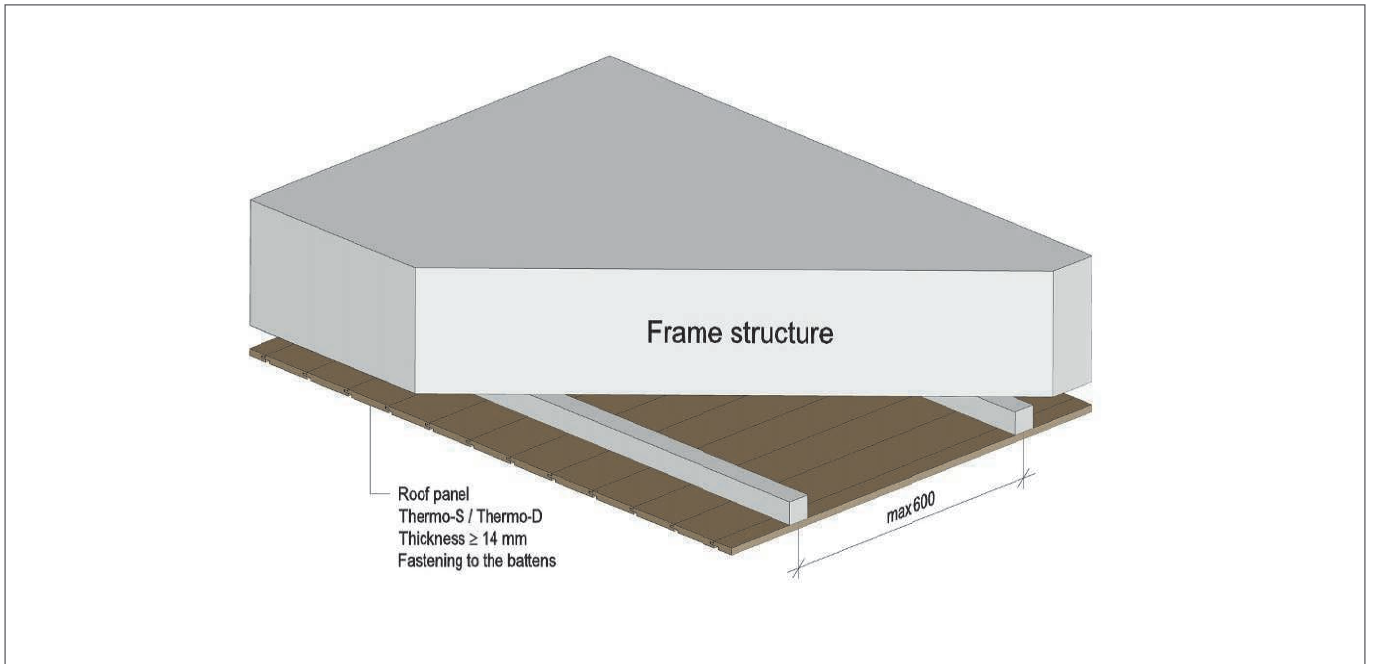


Figure 37. An example of ceiling cladding in a dry space.



Figure 38. ThermoWood® ceiling in Portugal

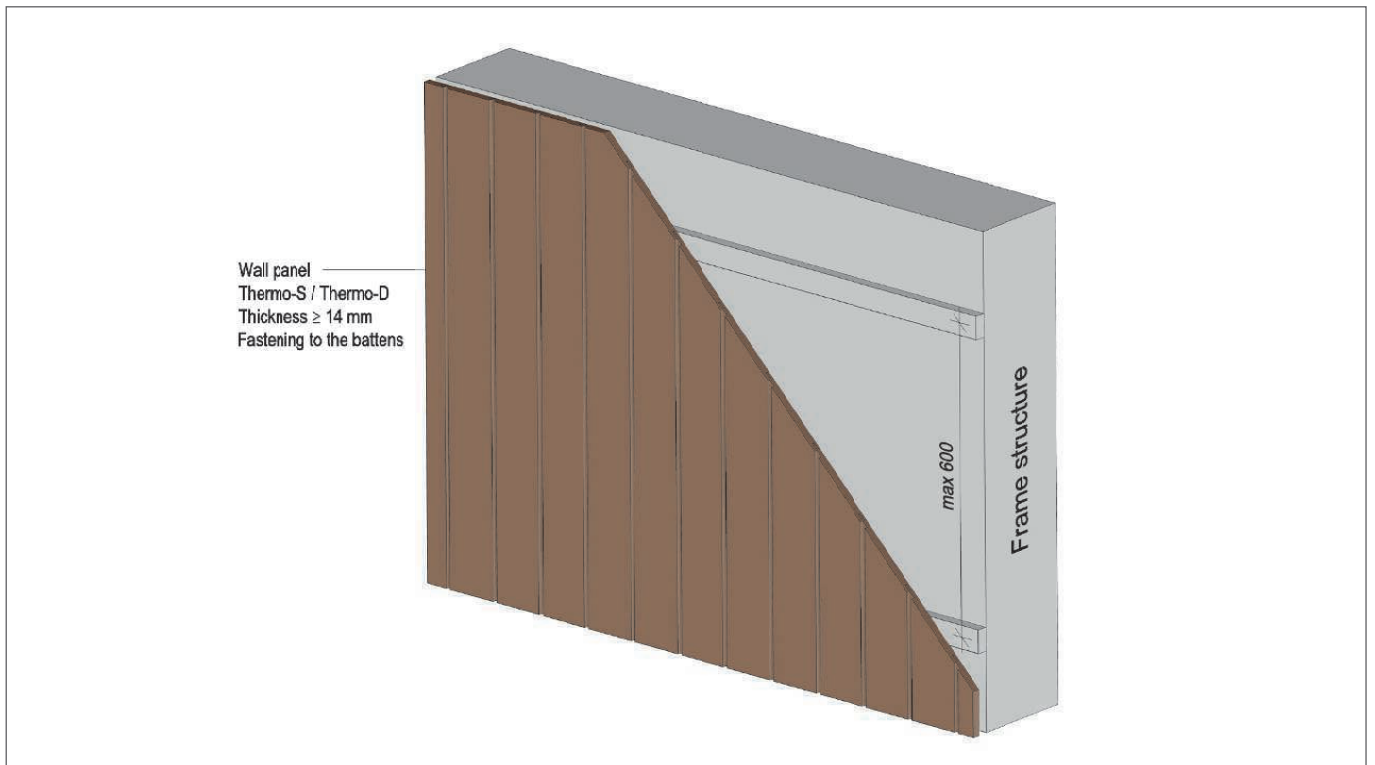


Figure 39. An example of interior wall cladding.



Figure 40. ThermoWood® products used for interior wall cladding in a café in Russia.

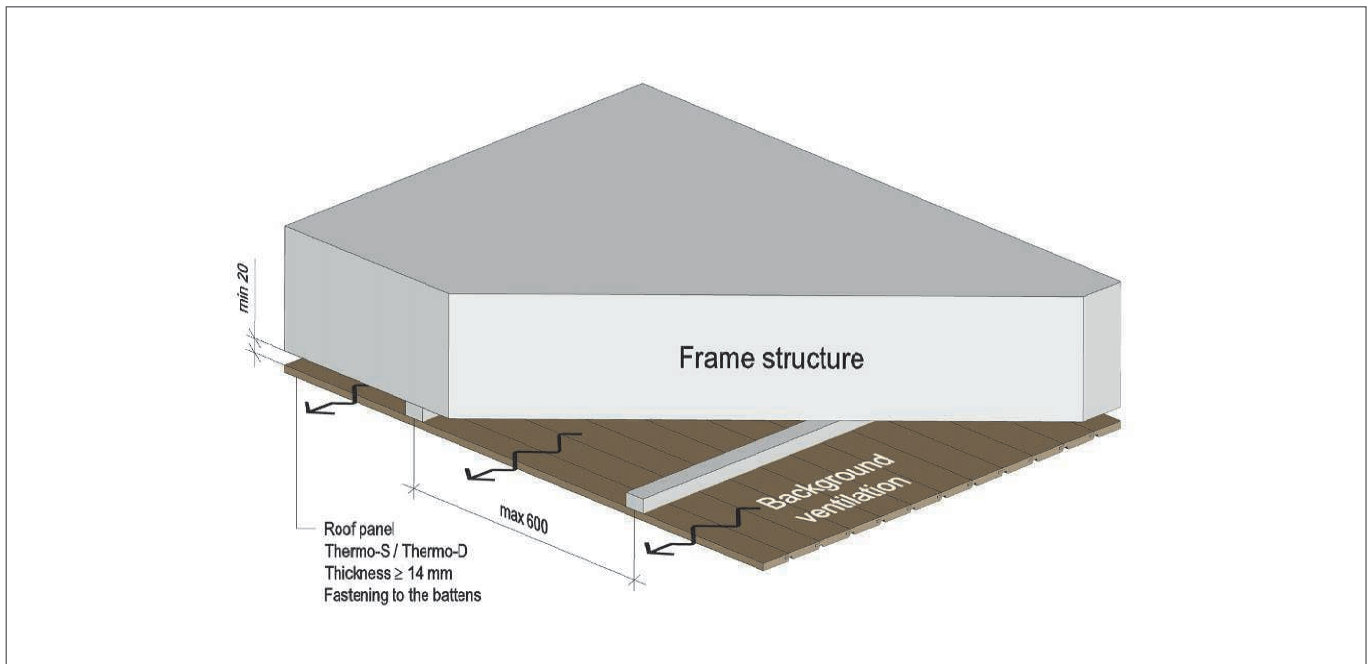


Figure 41. An example of ceiling cladding for a sauna.

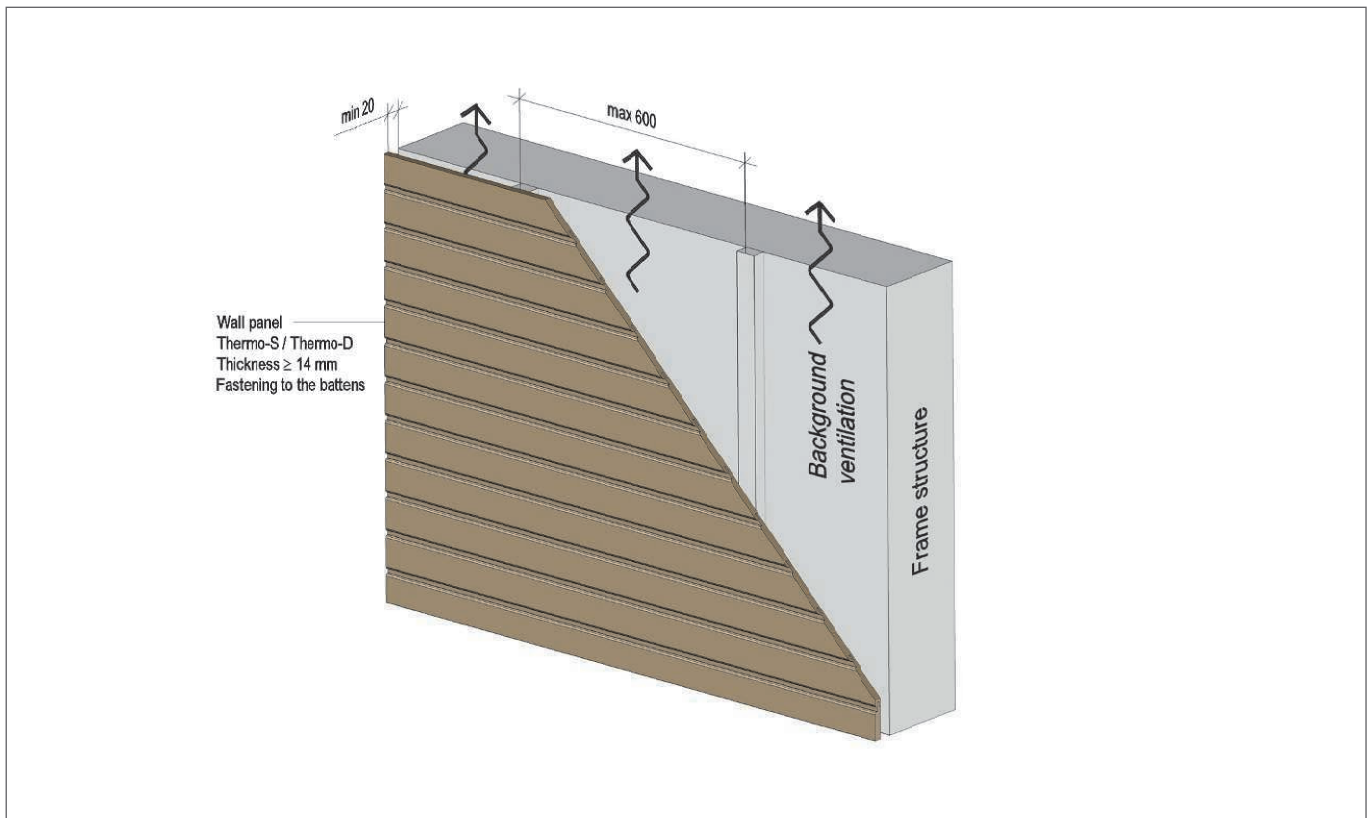


Figure 42. An example of wall cladding for a sauna.

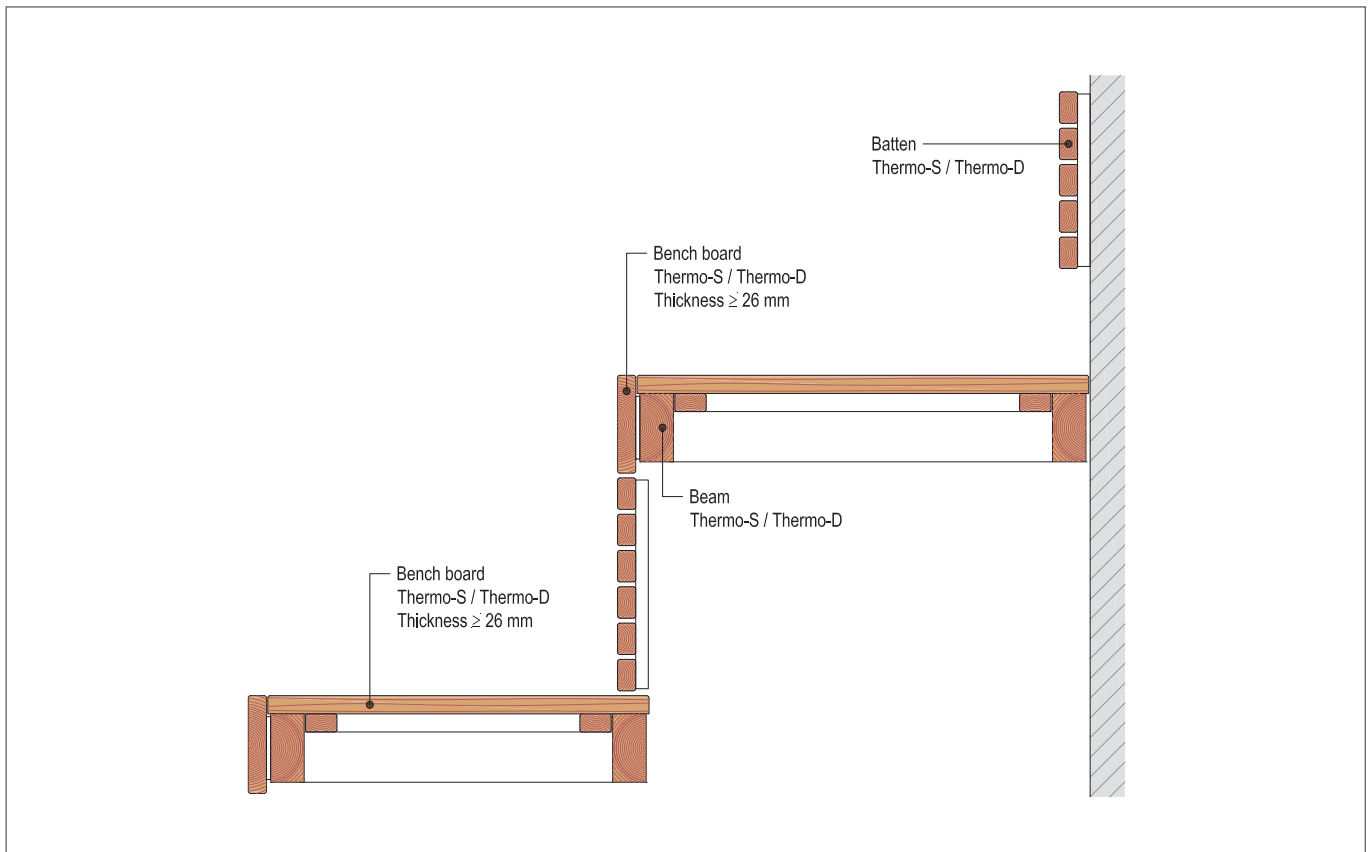


Figure 43. An example of a sauna's bench structures.



Figure 44. Sauna structures made of ThermoWood® products.

8.2 OUTDOOR USE

The equilibrium moisture content of ThermoWood® products and their shrinkage and swelling due to moisture are low, and therefore thinner indoor and outdoor cladding panels can be used compared

with standard timber. Air must always be allowed to circulate behind exterior cladding and the products must be fixed to a frame that is sufficiently robust.

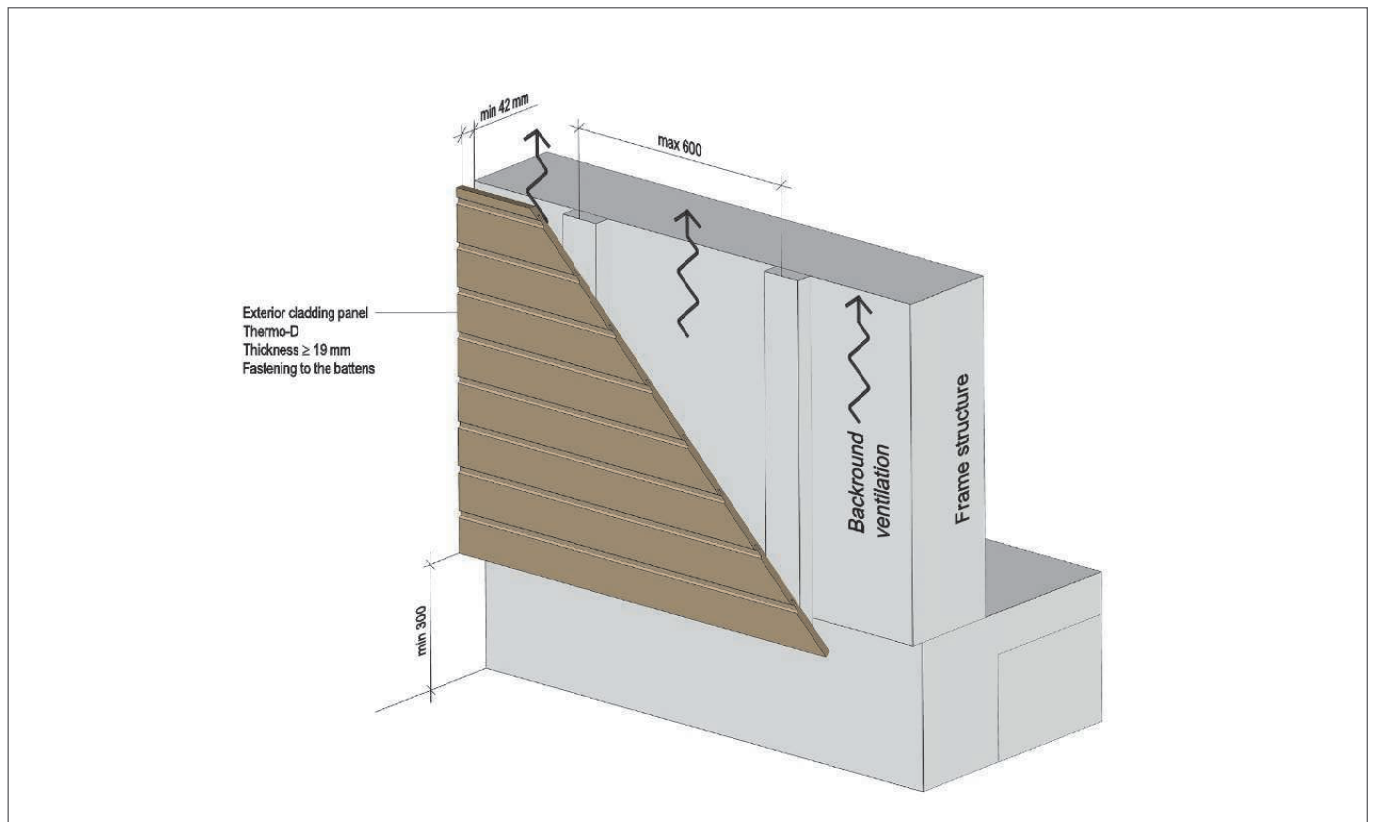


Figure 45. An example of exterior wall cladding.

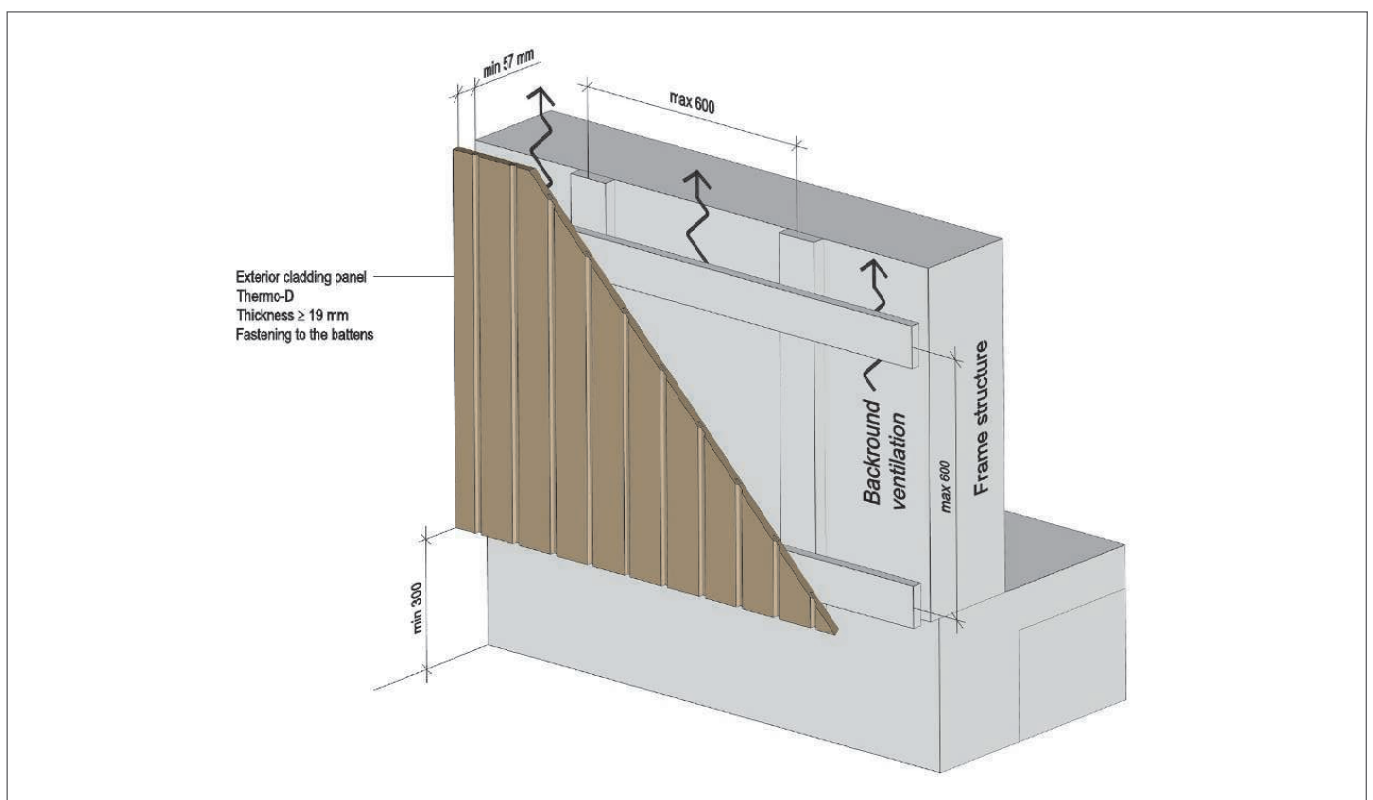


Figure 46. An example of exterior wall cladding.

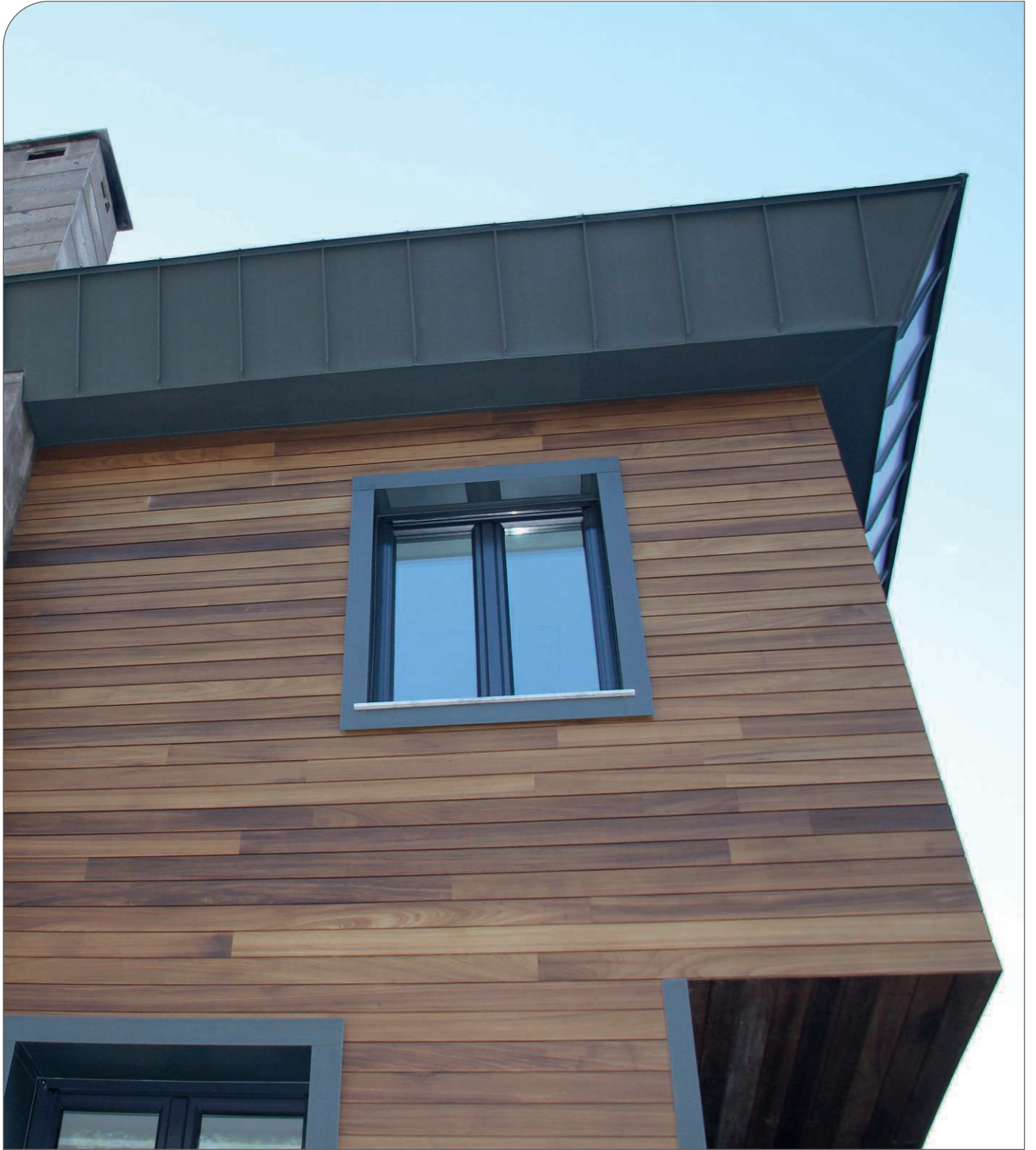


Figure 47. ThermoWood® exterior wall cladding.

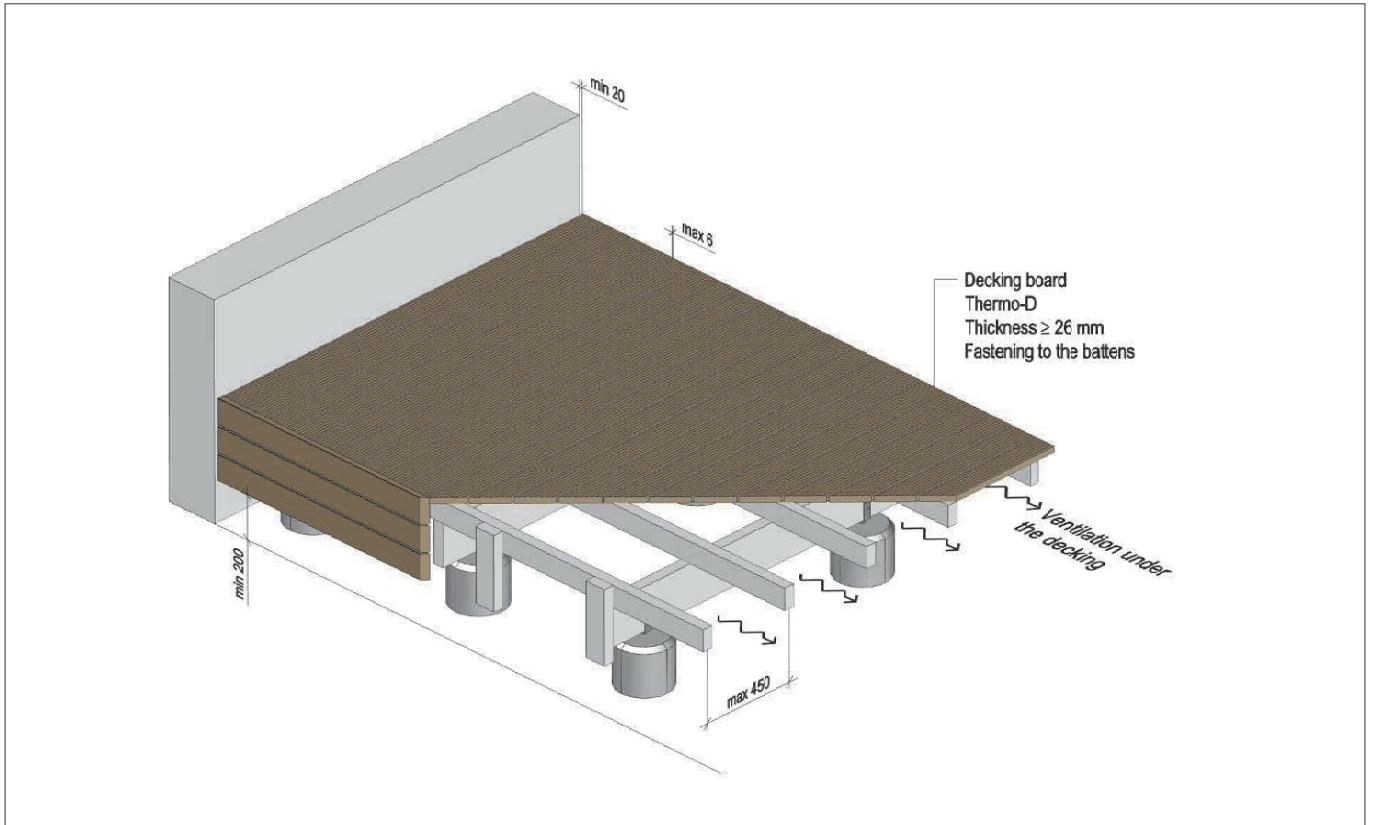


Figure 48. An example of patio structures.

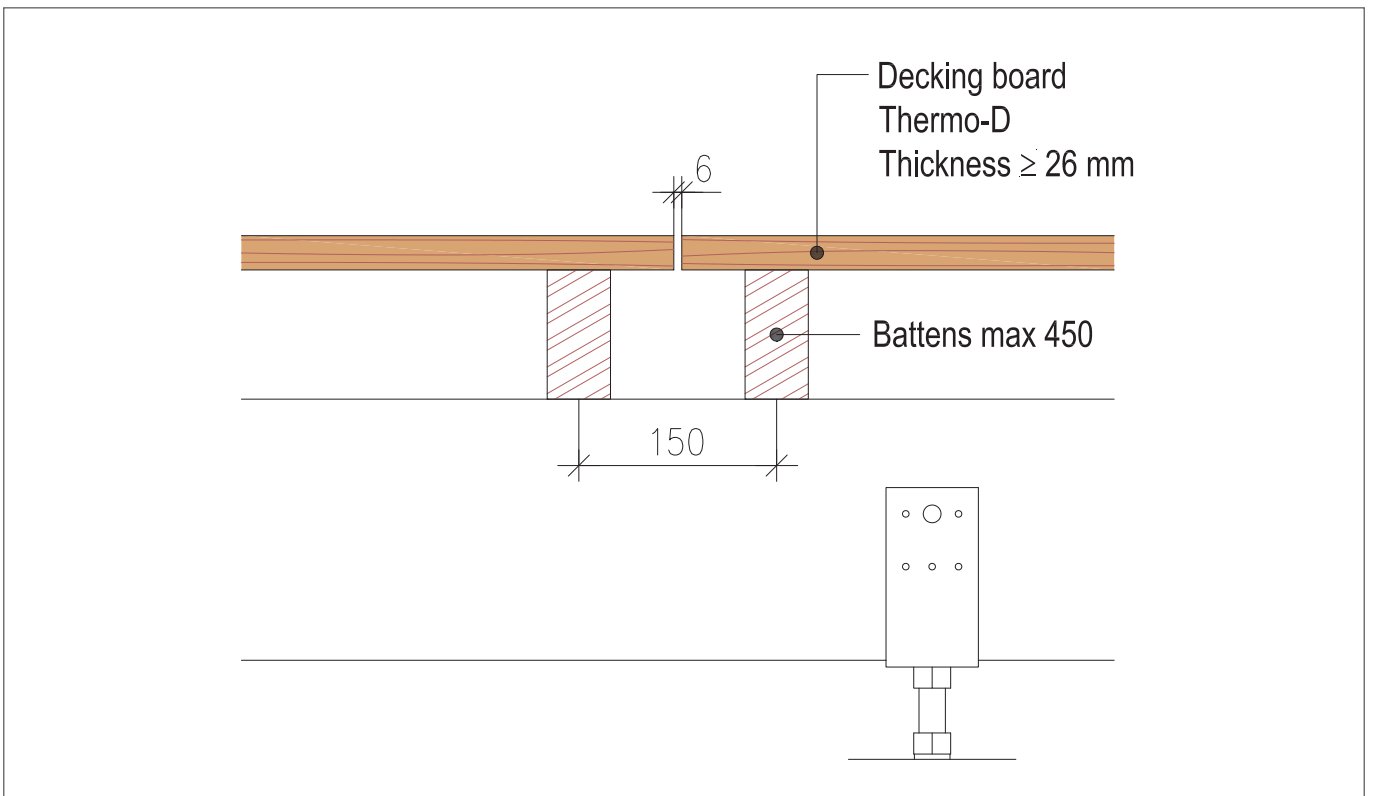


Figure 49. Decking board joint.

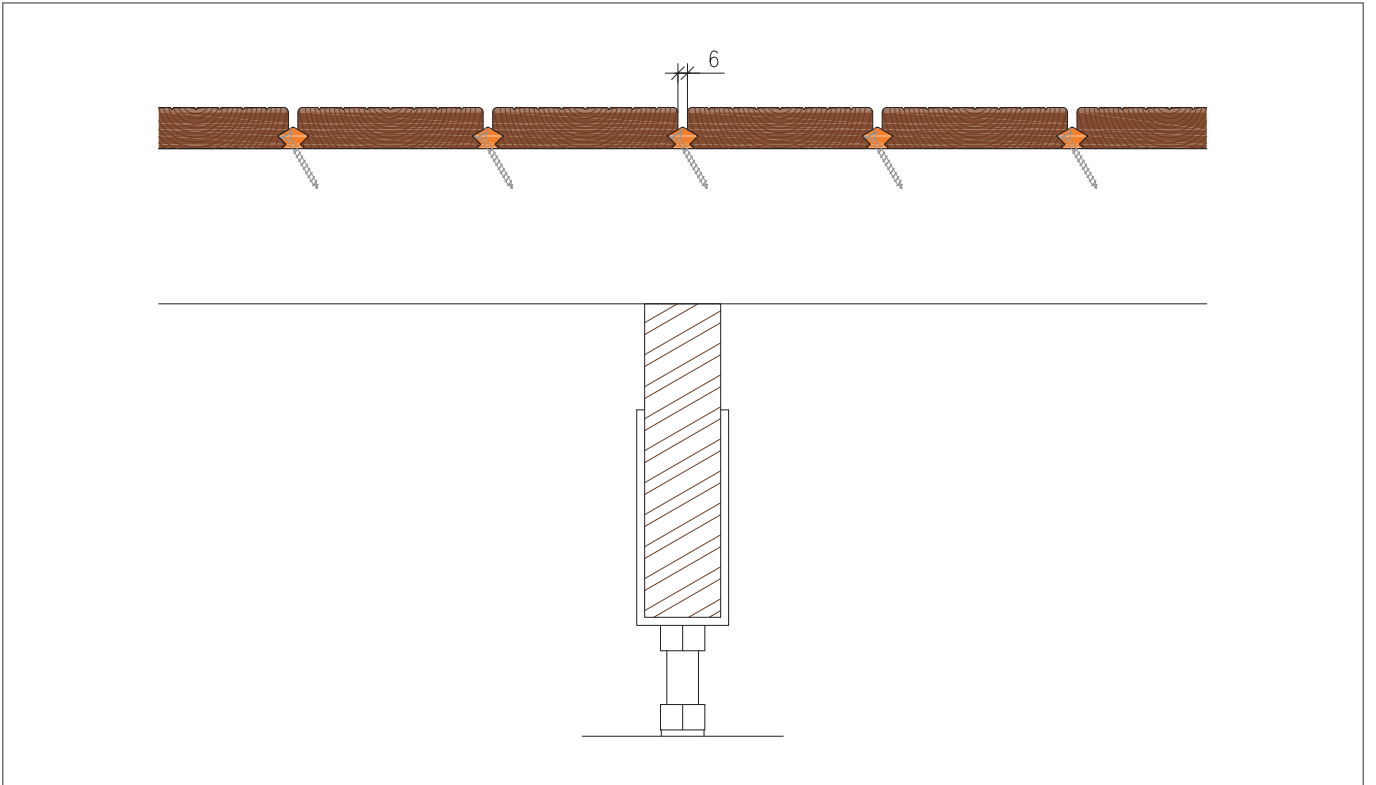


Figure 50. A hidden fastening of a decking board.



Figure 51. ThermoWood® patio.

9

INSTALLATION OF ThermoWood® CLADDING PRODUCTS

ThermoWood® products must be installed in accordance with the manufacturer's instructions. Below, we provide general instructions for the installation of the products. ThermoWood® products can be installed without unpacking them first if there is no need to condition them to the humidity levels at the installation location.

9.1 FASTENERS

Because of ThermoWood® products' pH value (acid), any fasteners must be made of stainless steel or stronger material in order to prevent corrosion. This applies to products used indoors and outdoors. Acid-resistant fasteners can also be used with ThermoWood® products.

Other fasteners react with ThermoWood®, causing staining around the fastener. If thermally modified timber is used in combination with other materials, possible reactions between the materials must be determined.

Table 11 presents the minimum requirements for the fasteners' protection against corrosion. The most common classes for stainless and acid-resistant steel are:

- Class A2 (AISI 304, EN 1.4301) is the most common stainless steel class
- Class A4 (AISI 316, EN 1.4401) is the most common acid-resistant steel class

9.2 MOUNTING

ThermoWood® products can be fixed in a traditional manner with nails and screws like any other timber products. Various hidden fastening systems are also available. The nails or screws used must be sufficiently long to extend through the mounting batten or board. The length of nails or screws must be selected so that they do not pierce any air or moisture barrier or similar structure.

When nails or screws are used, they must be fixed so that their head is on the same level as the timber surface (with the exception of Dyckert nails). If a nail gun is used to fix exterior cladding or decking boards, the machine must have a depth control mechanism to ensure that the nail head will be on the level with the timber surface. While this also affects visual quality, it is important in preventing water from entering the timber structure via the fastener. With nails and screws, it is important to ensure that they do not cause a crack in the timber (distance from the end). Pre-drilled holes can also be used for the fasteners.

9.3 JOINTS

Joints for ThermoWood® are made in a manner that prevents water from entering the timber via cut surfaces. The support at the joint must be sufficiently wide to ensure that fasteners installed through the timber are located the required distance from the end. When necessary, two separate supports are used at the joint (see Figure 52). With end-matched exterior cladding panels, tongue-and-groove joints can be placed next to the support to enable fasteners to be positioned at a suitable distance from the end (see Figure 53).

Table 11. Minimum requirements for fasteners' corrosion protection level in use with ThermoWood® products.

Application	Class	Quality	Type
Ceiling and wall cladding (dry space)	A2	AISI 304 (EN 1.4301)	Stainless steel
Floor (dry space)	A2	AISI 304 (EN 1.4301)	Stainless steel
Ceiling and wall cladding (bathroom)	A2	AISI 304 (EN 1.4301)	Stainless steel
Ceiling and wall cladding (sauna)	A2	AISI 304 (EN 1.4301)	Stainless steel
Sauna benches	A2	AISI 304 (EN 1.4301)	Stainless steel
Decking boards	A2	AISI 304 (EN 1.4301)	Stainless steel
Exterior cladding	A2	AISI 304 (EN 1.4301)	Stainless steel

Table 12. Examples of fixing methods

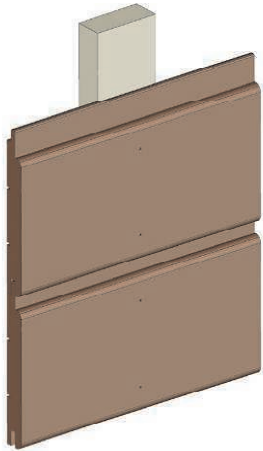
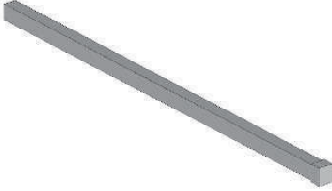
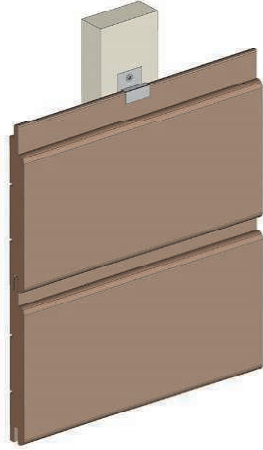
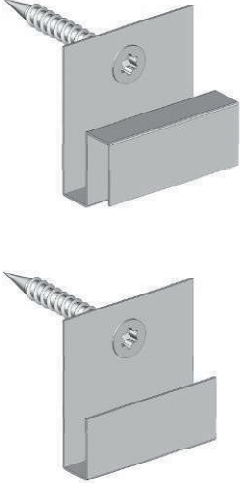
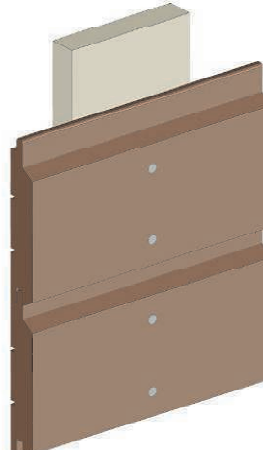

Fixing method	Fastener	Instructions
<p>Fixing through the side in a visible manner</p> 	<p>Dyckert</p> 	<ul style="list-style-type: none"> • Wall and ceiling cladding indoors • Products that are fixed via the tongue-and-groove structure are also available (hidden fixing) • The fastener heads must be about 1 mm below the timber surface • At least one fastener, when the panel width is ≤ 117 mm • Two fasteners, when the panel width is >117 mm
<p>Hidden fixing</p> 	<p>Clips</p> 	<ul style="list-style-type: none"> • Wall and ceiling cladding indoors • Wall and ceiling cladding outdoors • With vertical cladding, preventing the cladding products from sliding downwards is important (support at the bottom of the cladding or nails/screws at the top or bottom of the cladding)
<p>Fixing through the side in a visible manner</p> 	<p>Full-head ring shank nail</p> 	<ul style="list-style-type: none"> • Wall and ceiling cladding outdoors • Products that are fixed via the tongue-and-groove structure are also available (hidden fixing) • If a hole is pre-drilled, its diameter must be $0.5d-0.8d$ (d = nail thickness) • At least one fastener, when the panel width is ≤ 117 mm • Two fasteners, when the panel width is >117 mm

Table 12. Examples of fixing methods

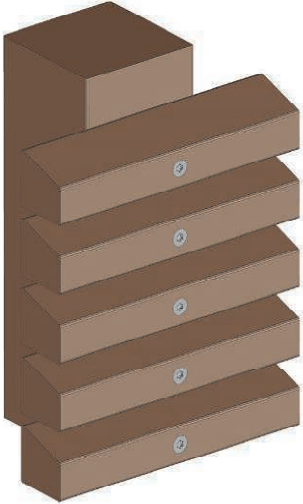

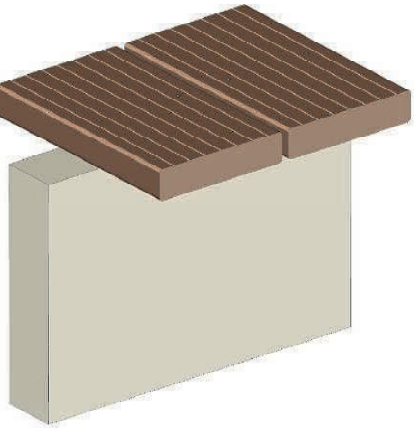

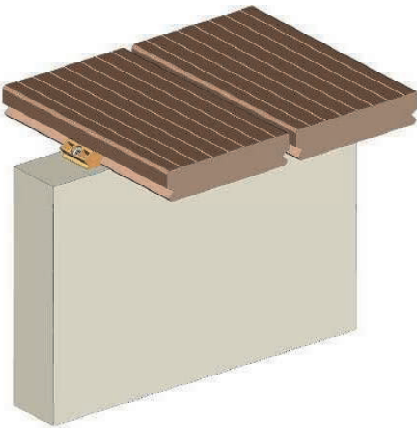
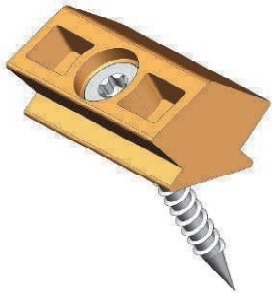
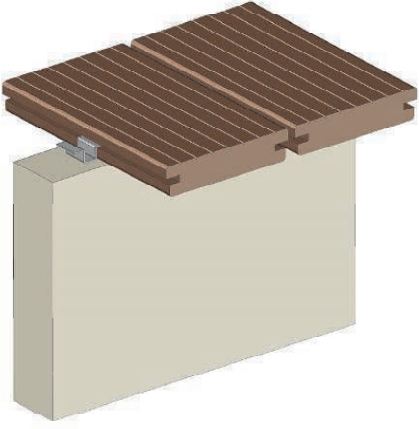


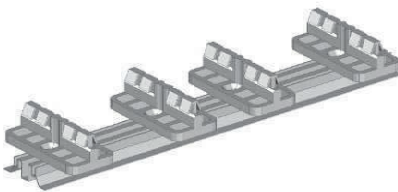
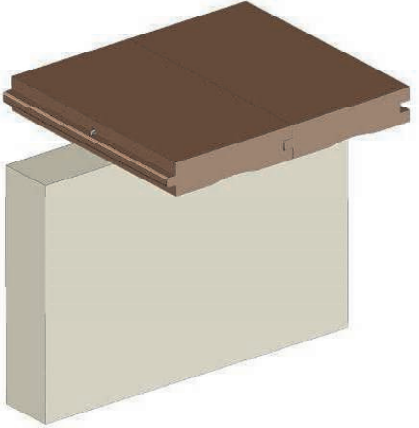

Fixing method	Fastener	Instructions
<p>Fixing through the side in a visible manner</p> 	<p>Screw</p> 	<ul style="list-style-type: none"> • Batten cladding outdoors • If a hole is pre-drilled, its diameter must be 0.5d–0.7d (d = nail thickness), but no larger than the inner diameter of the screw's threaded part
<p>Fixing through the side in a visible manner</p> 	<p>Decking screw (available in various colours)</p> 	<ul style="list-style-type: none"> • Decking boards • Jetty boards • If a hole is pre-drilled, its diameter must be 0.5d–0.7d (d = nail thickness), but no larger than the inner diameter of the screw's threaded part • Fixing with two screws
<p>Hidden fixing</p> 	<p>Profix (Lunawood)</p> 	<ul style="list-style-type: none"> • Decking boards • Jetty boards • Profix is a Lunawood product and therefore compatible only with other Lunawood products

Table 12. Examples of fixing methods

Fixing method	Fastener	Instructions
<p>Hidden fixing</p> 	<p>Clip</p> 	<ul style="list-style-type: none"> • Decking boards • Jetty boards
<p>Hidden fixing</p> 	<p>Clip</p> 	<ul style="list-style-type: none"> • Decking boards • Jetty boards
<p>Hidden fixing from the tongue-and-groove part</p> 	<p>Countersink screw</p> 	<ul style="list-style-type: none"> • Flooring indoors • If a hole is pre-drilled, its diameter must be $0.5d-0.7d$ (d = nail thickness), but no larger than the inner diameter of the screw's threaded part

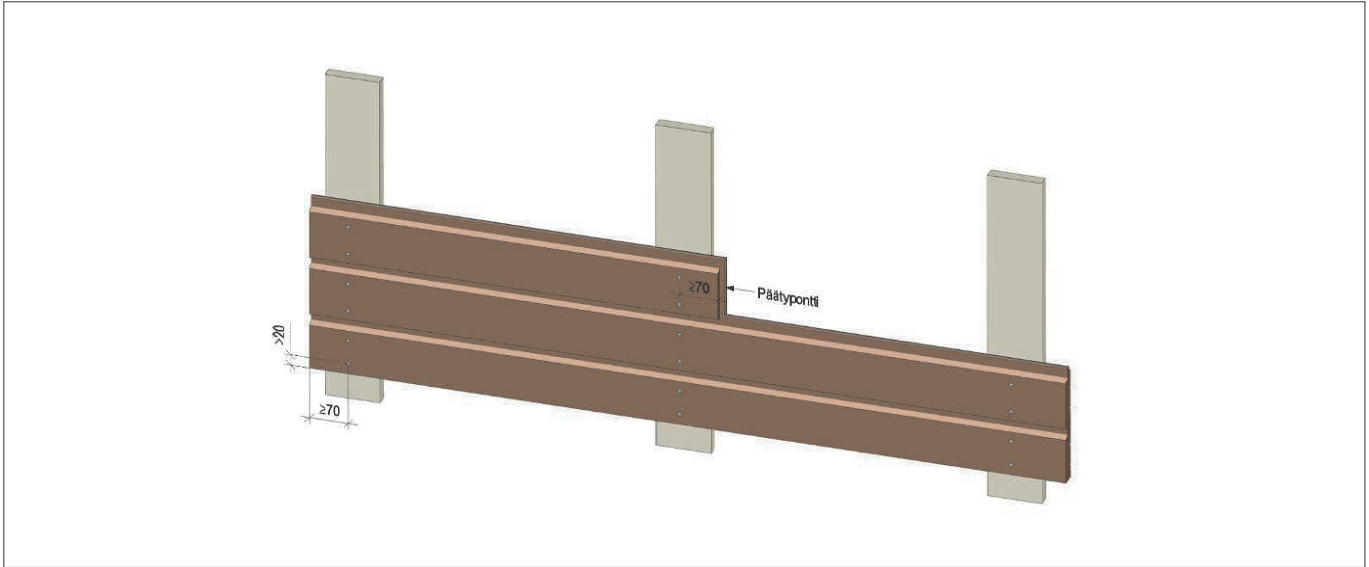


Figure 52. The recommended distances to edges and ends without pre-drilling with ThermoWood® products.

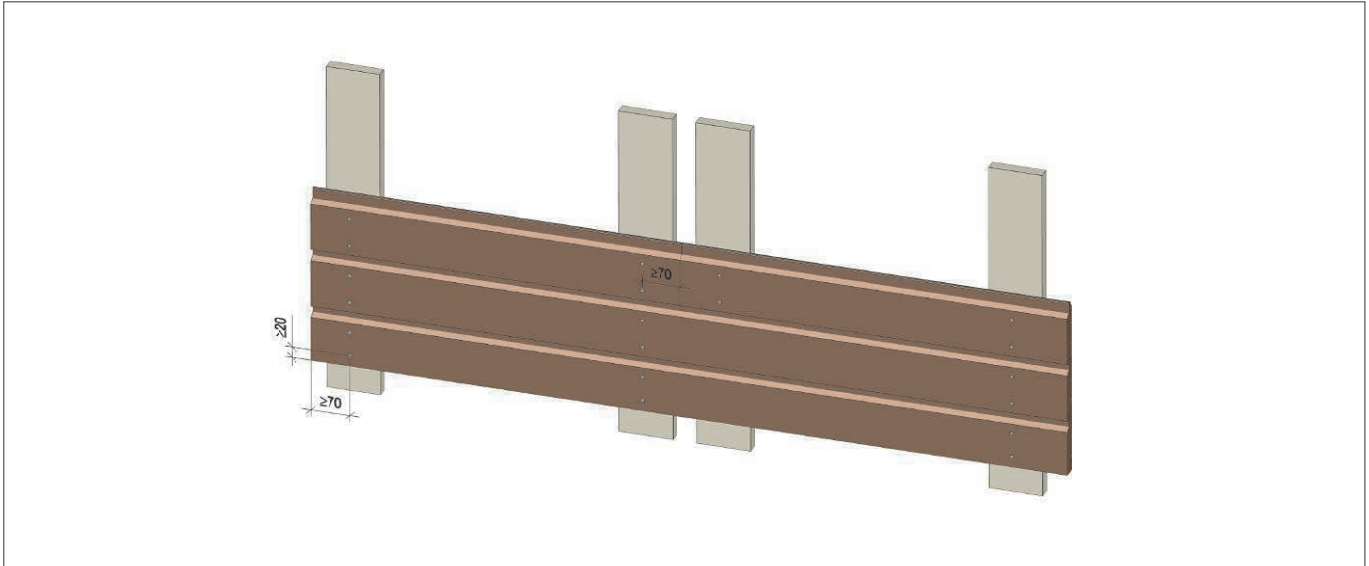


Figure 53. The recommended distances to edges and ends without pre-drilling with ThermoWood® products (without tongue and groove joint).

10 ThermoWood® IN THE CARPENTRY INDUSTRY

Thanks to its colour and dimensional stability, ThermoWood® timber makes an ideal material for furniture. Typical uses include both indoor and outdoor furniture.



Figure 54. ThermoWood® shutters.



Figure 55. ThermoWood® bench.



Figure 56. ThermoWood® bench.



Figure 57. ThermoWood® used as a worktop material.

11 REFERENCES

ThermoWood® products have been used successfully for a wide range of applications across the world. Below, we present some examples from various countries.



Figure 58. ThermoWood® products used for decking and exterior wall cladding on a Turkish hotel.



Figure 59. ThermoWood® exterior wall cladding on a Lithuanian restaurant.



Figure 60. Exterior cladding made of ThermoWood® products. (Turkey).



Figure 61. ThermoWood® exterior wall cladding with a naturally weathered appearance in Portugal.

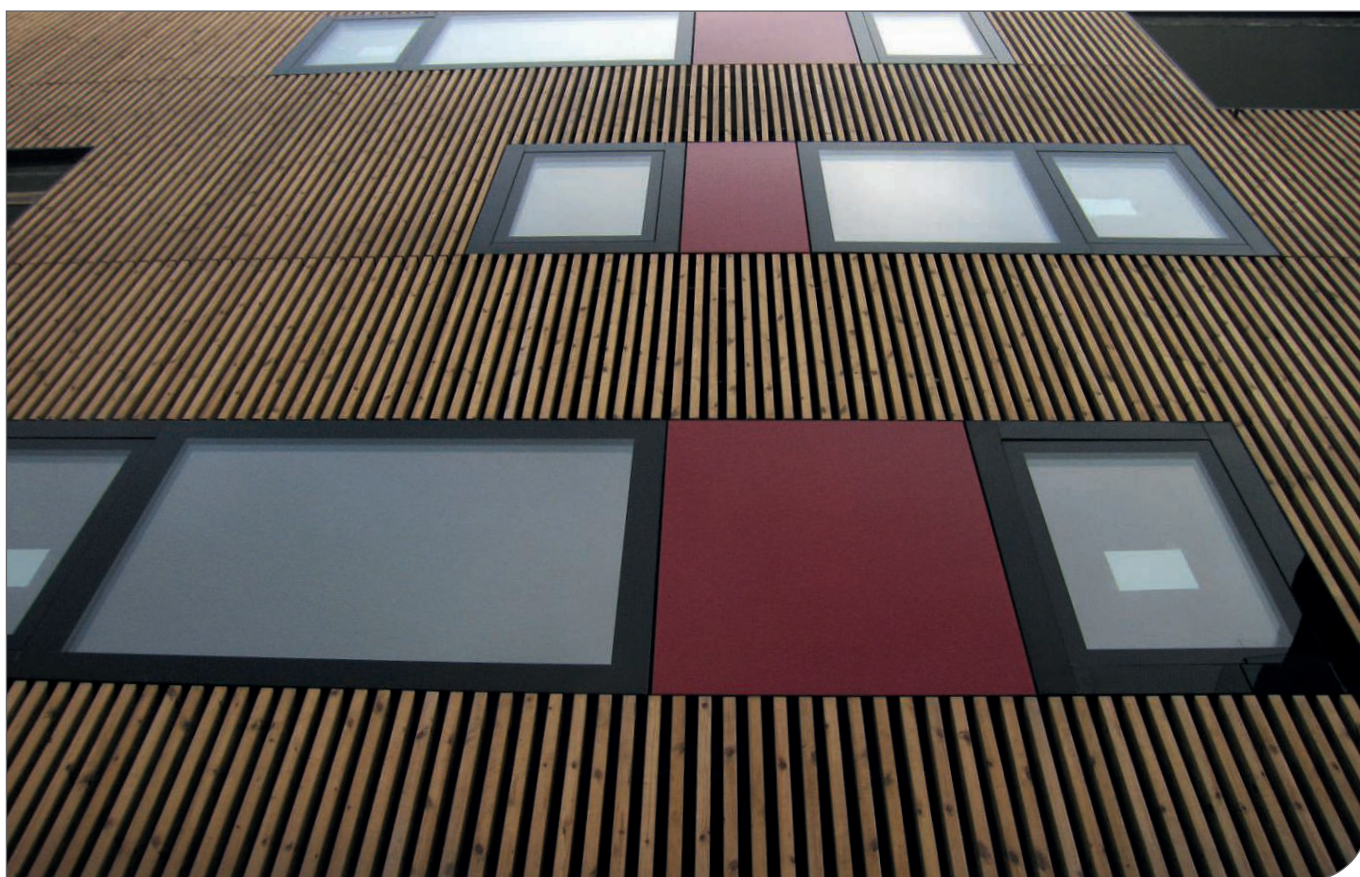


Figure 62. Exterior cladding made of ThermoWood® products.



Figure 63. ThermoWood® exterior wall cladding on a Spanish shopping centre.



Figure 64. ThermoWood® interior wall cladding made of Nordic spruce, product class Thermo-S.



Figure 65. ThermoWood® sauna benches.



Figure 66. ThermoWood® battens on a balcony railing.



Figure 67. ThermoWood® exterior wall cladding on a Portuguese church.

12

FURTHER INFORMATION

International Thermowood Association

Information on the members of the International Thermowood Association is available on the association's website.

www.thermowood.fi

PICTURES USED IN THE HANDBOOK

- Figure 1 Lunawood, Project: Centro Escolar de Mouriz, Architect: CNLL Architects / Nuno Lacerda, Portugali 2010, Photo: Fernando Guerra FG+SG
- Figure 2 Lunawood, Inspiroiva Creative
- Figure 4 Lunawood, Photo: Sami Tirkkonen
- Figure 6 Jartek Invest Oy
- Figure 7 Jartek Invest Oy
- Figure 8 Lunawood, Photo: STOODIO Oy
- Figure 12 Lunawood, Photo: Lunawood
- Figure 15 Lunawood, Photo: Lunawood
- Figure 16 Lunawood, Photo: Lunawood
- Figure 17 Lunawood, Photo: Lunawood
- Figure 18 Lunawood, Photo: Lunawood
- Figure 19 Tantimber
- Figure 20 Tantimber
- Figure 21 Tantimber, Architect: Mustafa Cicek, Photo: Cicek Insaat, Turkey - Izmir 2018
- Figure 33 Lunawood, Project: Hotel Gustavelund, Suomi 2019, Photo: Sami Tirkkonen
- Figure 36 Lunawood, Photo: Lunawood
- Figure 38 Lunawood, Project: Gerês house, Architect: Carvalho Araújo, Portugali 2015, Photo: NUDO
- Figure 40 Lunawood, Project: Café Geometry Of Taste, Architect: Natalia Reznik, Venäjä 2019, Photo: Lunawood
- Figure 44 SWM-Wood
- Figure 47 Tantimber, Turkey
- Figure 51 Lunawood, Architect: Plusarkkitehdit, Suomi 2016, Photo: Kuvio Ltd
- Figure 54 SWM-Wood, ThermoWood® Shutters
- Figure 55 Lunawood, Project: Urban Furniture VDNH Park Moscow, Punto Design, Venäjä 2019, Photo: Lunawood
- Figure 56 Lunawood, Project: Urban Furniture VDNH Park Moscow, Punto Design, Venäjä 2019, Photo: Lunawood
- Figure 57 SWM-Wood
- Figure 58 Tantimber, Architect: Mustafa Cicek, Photo: Cicek Insaat, Turkey - Izmir 2018
- Figure 59 Lunawood, Project: Foodcourt&Square, Architect: Do Architects, Liettua 2014, Photo: Norbert Tukaj
- Figure 60 Tantimber, Photo: Tantimber, Turkey -Istanbul, 2018
- Figure 61 Lunawood, Project: RV House, Architect: Marta Rocha & Fabien Vacelet, Portugali 2015, Photo: Tiago Casanova
- Figure 62 SWM-Wood
- Figure 63 Lunawood, Project: Mercat Barcelona, Architect: Maria Manrique & Gisela Planas, Espanja 2016, Photo: Pere Virgili
- Figure 64 Lunawood, Photo: Lunawood
- Figure 65 SWM-Wood
- Figure 66 SWM-Wood
- Figure 67 Lunawood, Project: S. Pedro De Avioso Chapel, Architect: Susana Carvalho, Portugali 2018, Photo: Fábio Silva, Banema



This handbook offers essential information on thermally modified timber products sold under the ThermoWood® trademark. Its goal is to provide objective information on ThermoWood® products and their use.

It is intended for Architects and structural designers, retailers, component and element manufacturers, contractors, carpenters and educational institutes. The ThermoWood® handbook is available in Finnish and English.

The Foundation for Quality of Construction Products supported the work on this handbook financially.

